

Pressure transmitter

For demanding industrial applications

Model S-20

WIKA data sheet PE 81.61



For further approvals,
see page 12

Applications

- Critical industrial applications
- Demanding applications in research and development
- Harsh environments in the process industry

Special features

- Extreme variety, available at short notice from 1 piece
- High accuracy, low temperature error, selectable adjustment temperature
- Proven technology
- Special media and special versions



Pressure transmitter, model S-20

Description

The S-20 pressure transmitter is a versatile specialist for demanding tasks and harsh environments. The measuring ranges from 0 ... 0.4 to 0 ... 1,600 bar [0 ... 5.8 to 0 ... 23,200 psi] can be combined with many output signals, electrical connections and process connections. These configuration options allow for over 1 billion versions and leave much room for tailor-made customisation. The S-20 is also at home in critical industrial applications and works reliably with heat, vibrations or aggressive media.

Extreme variety, available at short notice from 1 piece

The S-20 can be freely configured and optimally adapted to the plant requirements. All common versions are available from a batch size of 1 within a few days.

High accuracy, low temperature error, selectable adjustment temperature

The S-20 measures pressures particularly accurately and reliably and is available in three accuracy classes. The

selectable adjustment temperatures of +4 °C, +40 °C, +60 °C and +80 °C [+39°F, +104 °F, +140 °F, +176 °F] reduce the temperature error to a minimum.

Proven technology

The S-20 is based on proven technologies, tried and tested in the field. With up to 100 million load cycles and a long-term stability to < 0.1 %, it constantly provides precise data for processes and plants. Regular audits permanently ensure highest quality standards.

Special media and special versions

Versions for special media, e.g. oxygen or hydrogen applications, high temperatures and cleanliness levels are available. In addition, the S-20 can be delivered with IP68 and IP6K9K ingress protection.

Specifications

The model S-20 is available with an improved non-linearity. Depending on the selected non-linearity the following values result:

Accuracy specifications	Non-linearity ≤ ±0.5 % of span	Non-linearity ≤ ±0.25 % of span	Non-linearity ≤ ±0.125 % of span ¹⁾
Non-linearity per BFSL per IEC 61298-2	≤ ±0.5 % of span	≤ ±0.25 % of span	≤ ±0.125 % of span
Non-linearity per terminal method per IEC 61298-2	≤ ±1 % of span	≤ ±0.5 % of span	≤ ±0.25 % of span
Accuracy at adjustment temperature	→ See "Max. measured error per IEC 61298-2"		
Max. measured error per IEC 61298-2	≤ ±1 % of span	≤ ±0.5 % of span	≤ ±0.25 % of span

1) Restrictions for the non-linearity of 0.125 % BFSL or 0.25 % per terminal method:
 Available output signals: 4 ...20 mA and DC 0 ... 10 V
 Available measuring ranges: All measuring ranges specified in the data sheet
 Other output signals or measuring ranges on request.

Further details on: Accuracy specifications	
Non-repeatability per IEC 61298-2	≤ 0.1 % of span
Zero point error	<ul style="list-style-type: none"> ■ ≤ ±0.2 % of span, factory-set ■ ≤ ±0.1 % of span, factory-set ¹⁾
Temperature hysteresis	≤ 0.1 % of span at > 80 °C [176 °F]
Long-term drift per IEC 61298-2	<ul style="list-style-type: none"> ■ ≤ ±0.1 % of span ■ ≤ ±0.2 % of span (with special measuring ranges and measuring ranges < 1 bar [15 psi])
Temperature error (for adjustment temperature 15 ... 25 °C [59 ... 77°F])	→ See "Adjustment temperature" For measuring ranges < 1 bar [15 psi], special measuring ranges and instruments with an increased overpressure limit the respective temperature error increases by 0.5 % of span
Adjustment temperature	<ul style="list-style-type: none"> ■ 15 ... 25 °C [59 ... 77 °F] ■ 4 °C ±5 °C [39.2 °F ±9 °F] ■ 40 °C ±5 °C [104 °F ±9 °F] ■ 60 °C ±5 °C [140 °F ±9 °F] ■ 80 °C ±5 °C [176 °F ±9 °F]
Additional zero point error depending on the mounting position for measuring ranges ≤ 1 bar [15 psi]	
Mounting position 180°, vertical, top process connection	≤ 1 mbar [≤ 0.015 psi]
Mounting position 90°, horizontal, lateral process connection	≤ 0.6 mbar [≤ 0.009 psi]
Reference conditions	Per IEC 61298-1

1) Restrictions for zero point error 0.1 % (factory-set):
 Available output signals: 4 ...20 mA and DC 0 ... 10 V
 Available measuring ranges: all gauge pressure measuring ranges specified in the data sheet
 Not available in combination with optional adjustment temperatures.

Temperature error

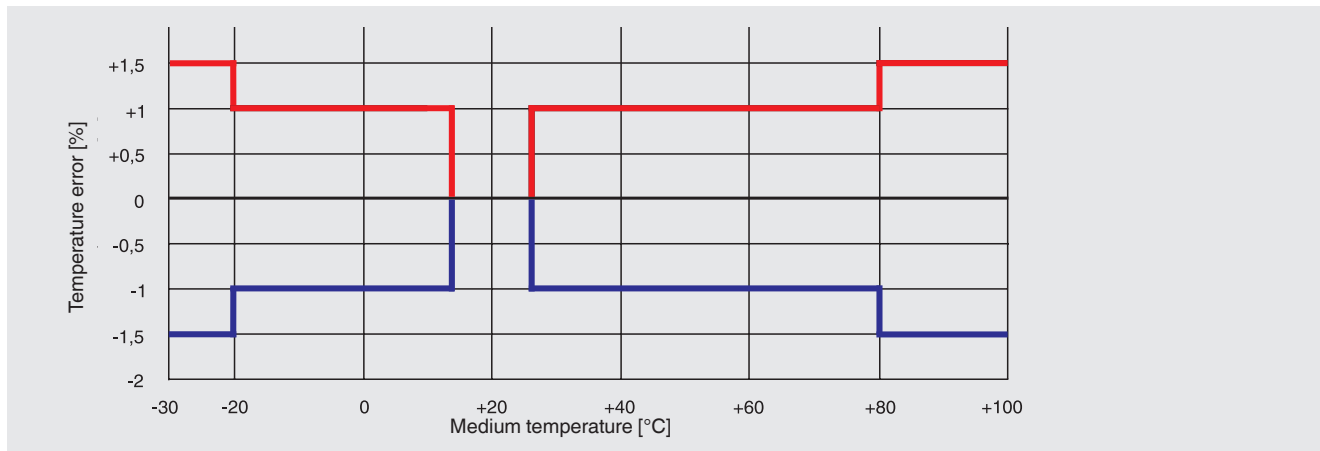

Measuring ranges, gauge pressure

bar	
0 ... 0.4	0 ... 40
0 ... 0.6	0 ... 60
0 ... 1	0 ... 100
0 ... 1.6	0 ... 160
0 ... 2.5	0 ... 250
0 ... 4	0 ... 400
0 ... 6	0 ... 600
0 ... 10	0 ... 1,000
0 ... 16	0 ... 1,600
0 ... 25	

psi	
0 ... 10	0 ... 600
0 ... 15	0 ... 750
0 ... 25	0 ... 1,000
0 ... 30	0 ... 1,500
0 ... 50	0 ... 2,000
0 ... 60	0 ... 3,000
0 ... 100	0 ... 4,000
0 ... 150	0 ... 5,000
0 ... 160	0 ... 6,000
0 ... 200	0 ... 7,500
0 ... 250	0 ... 10,000
0 ... 300	0 ... 15,000
0 ... 400	0 ... 20,000
0 ... 500	

Measuring ranges, absolute pressure

bar abs.	
0 ... 0.4	0 ... 6
0 ... 0.6	0 ... 10
0 ... 1	0 ... 16
0 ... 1.6	0 ... 25
0 ... 2.5	0 ... 40
0 ... 4	

psi abs.	
0 ... 10	0 ... 150
0 ... 15	0 ... 160
0 ... 25	0 ... 200
0 ... 30	0 ... 250
0 ... 50	0 ... 300
0 ... 60	0 ... 400
0 ... 100	0 ... 500

Vacuum and +/- measuring ranges

bar	
-0.4 ... 0	-1 ... +5
-0.6 ... 0	-1 ... +9
-1 ... 0	-1 ... +15
-1 ... +0.6	-1 ... +24
-1 ... +1.5	-1 ... +39
-1 ... +3	-1 ... +59

psi	
-30 inHg ... 0	-30 inHg ... +100
-30 inHg ... +15	-30 inHg ... +160
-30 inHg ... +30	-30 inHg ... +200
-30 inHg ... +45	-30 inHg ... +300
-30 inHg ... +60	-30 inHg ... +500

Further details on: Measuring ranges	
Units	<ul style="list-style-type: none"> ■ bar ■ psi ■ kg/cm² ■ MPa ■ kPa
Maximum working pressure	→ Corresponds to the upper measuring range value / measuring range full scale value
Special measuring ranges	From 0 ... 0.4 to 0 ... 1,600 bar [0 ... 10 to 0 ... 20,000 psi] available on request. Special measuring ranges have a reduced long-term stability and higher temperature errors.
Overpressure limit	The overpressure limit is based on the measuring range. Depending on the selected process connection and the seal, restrictions in overpressure limit can result. A higher overpressure limit will result in a higher temperature error.
Measuring ranges < 10 bar [150 psi]	<ul style="list-style-type: none"> ■ 3 times ■ 5 times
Measuring ranges ≥ 10 bar [150 psi]	<ul style="list-style-type: none"> ■ 2 times ¹⁾ ■ 3 times ^{2) 3)}
Vacuum resistance	Yes

1) Restriction: max. 60 bar [870 psi] with absolute pressure

2) Only possible for gauge pressure measuring ranges ≤ 400 bar [5,800 psi]

3) Only possible for absolute pressure measuring ranges < 16 bar [220 psi]

Process connection					
Standard	Thread size	Max. measuring range	Overpressure limit	Pressure port	Seal
DIN EN ISO 1179-2 (formerly DIN 3852-E)	G ¼ A ¹⁾	600 bar [8,700 psi]	858 bar [12,400 psi]	<ul style="list-style-type: none"> ■ 2.5 mm [0.1 in] ■ 0.3 mm [0.01 in] ■ 0.6 mm [0.02 in] ■ 6 mm [0.24 in] ²⁾ 	<ul style="list-style-type: none"> ■ NBR ■ FPM/FKM ■ EPDM
		1,000 bar [15,000 psi]	1,480 bar [21,400 psi]	<ul style="list-style-type: none"> ■ 2.5 mm [0.1 in] ■ 0.3 mm [0.01 in] ■ 0.6 mm [0.02 in] 	<ul style="list-style-type: none"> ■ FPM/FKM
	G ½ A	600 bar [8,700 psi]	858 bar [12,440 psi]	<ul style="list-style-type: none"> ■ 2.5 mm [0.1 in] ■ 0.3 mm [0.01 in] ■ 0.6 mm [0.02 in] ■ 12 mm [0.48 in] ²⁾ 	<ul style="list-style-type: none"> ■ NBR ■ FPM/FKM
DIN EN ISO 9974-2 (formerly DIN 3852-E)	M14 x 1.5	600 bar [8,700 psi]	858 bar [12,440 psi]	<ul style="list-style-type: none"> ■ 2.5 mm [0.1 in] ■ 0.3 mm [0.01 in] ■ 0.6 mm [0.02 in] 	<ul style="list-style-type: none"> ■ NBR ■ FPM/FKM ■ EPDM
EN 837	G ⅛ B	400 bar [5,800 psi]	572 bar [8,290 psi]	<ul style="list-style-type: none"> ■ 2.5 mm [0.1 in] 	<ul style="list-style-type: none"> ■ Copper
	G ¼ B ¹⁾	1,000 bar [15,000 psi]	1,480 bar [21,400 psi]	<ul style="list-style-type: none"> ■ 2.5 mm [0.1 in] ■ 0.3 mm [0.01 in] ■ 0.6 mm [0.02 in] 	<ul style="list-style-type: none"> ■ Copper ■ Stainless steel ■ Without
	G ¼, female	1,000 bar [15,000 psi]	1,480 bar [21,400 psi]	<ul style="list-style-type: none"> ■ 2.5 mm [0.1 in] 	-
	G ⅜ B	1,000 bar [15,000 psi]	1,480 bar [21,400 psi]	<ul style="list-style-type: none"> ■ 2.5 mm [0.1 in] ■ 0.3 mm [0.01 in] ■ 0.6 mm [0.02 in] 	<ul style="list-style-type: none"> ■ Copper ■ Stainless steel ■ Without
	G ½ B ¹⁾	1,000 bar [15,000 psi]	1,480 bar [21,400 psi]	<ul style="list-style-type: none"> ■ 2.5 mm [0.1 in] ■ 0.3 mm [0.01 in] ■ 0.6 mm [0.02 in] 	<ul style="list-style-type: none"> ■ Copper ■ Stainless steel ■ Without
		1,600 bar [23,200 psi]	2,288 bar [33,180 psi]	<ul style="list-style-type: none"> ■ 2.5 mm [0.1 in] ■ 0.6 mm [0.02 in] 	-

Process connection					
Standard	Thread size	Max. measuring range	Overpressure limit	Pressure port	Seal
DIN 16288	M12 x 1.5	1,000 bar [15,000 psi]	1,480 bar [21,400 psi]	<ul style="list-style-type: none"> ■ 2.5 mm [0.1 in] ■ 0.3 mm [0.01 in] ■ 0.6 mm [0.02 in] 	<ul style="list-style-type: none"> ■ Copper ■ Stainless steel ■ Without
	M20 x 1.5	1,000 bar [15,000 psi]	1,480 bar [21,400 psi]	<ul style="list-style-type: none"> ■ 2.5 mm [0.1 in] ■ 0.3 mm [0.01 in] ■ 0.6 mm [0.02 in] 	<ul style="list-style-type: none"> ■ Copper ■ Stainless steel ■ Without
		1,600 bar [23,200 psi]	2,288 bar [33,180 psi]	<ul style="list-style-type: none"> ■ 2.5 mm [0.1 in] 	-
ANSI/ASME B1.20.1	1/8 NPT	400 bar [5,800 psi]	572 bar [8,290 psi]	<ul style="list-style-type: none"> ■ 2.5 mm [0.1 in] 	-
	1/4 NPT	1,000 bar [15,000 psi]	1,480 bar [21,400 psi]	<ul style="list-style-type: none"> ■ 2.5 mm [0.1 in] ■ 0.3 mm [0.01 in] ■ 0.6 mm [0.02 in] ■ 6 mm [0.24 in]²⁾ 	-
		1,000 bar [15,000 psi]	1,480 bar [21,400 psi]	<ul style="list-style-type: none"> ■ 2.5 mm [0.1 in] 	-
	1/4 NPT, female	1,000 bar [15,000 psi]	1,480 bar [21,400 psi]	<ul style="list-style-type: none"> ■ 2.5 mm [0.1 in] ■ 0.3 mm [0.01 in] ■ 0.6 mm [0.02 in] ■ 12 mm [0.48 in]²⁾ 	-
	1/2 NPT ¹⁾	1,000 bar [15,000 psi]	1,480 bar [21,400 psi]	<ul style="list-style-type: none"> ■ 2.5 mm [0.1 in] ■ 0.3 mm [0.01 in] ■ 0.6 mm [0.02 in] ■ 12 mm [0.48 in]²⁾ 	-
	1,600 bar [23,200 psi]	2,288 bar [33,180 psi]	<ul style="list-style-type: none"> ■ 2.5 mm [0.1 in] 	-	
SAE J514	7/16-20 UNF-2A O-ring Boss	600 bar [8,700 psi]	858 bar [12,400 psi]	<ul style="list-style-type: none"> ■ 2.5 mm [0.1 in] ■ 0.3 mm [0.01 in] ■ 0.6 mm [0.02 in] 	<ul style="list-style-type: none"> ■ NBR ■ FPM/FKM
	7/16-20 UNF-2A 74°	800 bar [11,600 psi]	1,144 bar [16,590 psi]	<ul style="list-style-type: none"> ■ 2.5 mm [0.1 in] ■ 0.3 mm [0.01 in] ■ 0.6 mm [0.02 in] 	-
	9/16-18 UNF-2A O-ring Boss	600 bar [8,700 psi]	858 bar [12,400 psi]	<ul style="list-style-type: none"> ■ 2.5 mm [0.1 in] ■ 0.3 mm [0.01 in] ■ 0.6 mm [0.02 in] 	<ul style="list-style-type: none"> ■ NBR ■ FPM/FKM
-	9/16-18 UNF, female F250-C	1,600 bar [23,200 psi]	2,288 bar [33,180 psi]	<ul style="list-style-type: none"> ■ 2.5 mm [0.1 in] 	-
ISO 7	R 1/4 ¹⁾	1,000 bar [15,000 psi]	1,480 bar [21,400 psi]	<ul style="list-style-type: none"> ■ 2.5 mm [0.1 in] ■ 0.3 mm [0.01 in] ■ 0.6 mm [0.02 in] 	-
	R 3/8	1,000 bar [15,000 psi]	1,480 bar [21,400 psi]	<ul style="list-style-type: none"> ■ 2.5 mm [0.1 in] ■ 0.3 mm [0.01 in] ■ 0.6 mm [0.02 in] 	-
	R 1/2	1,000 bar [15,000 psi]	1,480 bar [21,400 psi]	<ul style="list-style-type: none"> ■ 2.5 mm [0.1 in] ■ 0.3 mm [0.01 in] ■ 0.6 mm [0.02 in] 	-
KS	PT 1/4 ¹⁾	1,000 bar [15,000 psi]	1,480 bar [21,400 psi]	<ul style="list-style-type: none"> ■ 2.5 mm [0.1 in] ■ 0.3 mm [0.01 in] ■ 0.6 mm [0.02 in] 	-
	PT 3/8	1,000 bar [15,000 psi]	1,480 bar [21,400 psi]	<ul style="list-style-type: none"> ■ 2.5 mm [0.1 in] ■ 0.3 mm [0.01 in] ■ 0.6 mm [0.02 in] 	-
	PT 1/2	1,000 bar [15,000 psi]	1,480 bar [21,400 psi]	<ul style="list-style-type: none"> ■ 2.5 mm [0.1 in] ■ 0.3 mm [0.01 in] ■ 0.6 mm [0.02 in] 	-

1) For medium temperatures to 150 °C [302 °F] or 200 °C [392 °F] available with cooling element.

2) Wider pressure port with 6 mm [0.24 in] or 12 mm [0.48 in] only feasible for measuring ranges up to and including 0 ...40 bar [0 ... 500 psi].

Details must be tested separately in the respective application. The specified values for the overpressure limit serve only as a rough orientation. The values depend on the temperature, the seal used, the selected torque, the type and the material of the mating thread and the prevailing operating conditions.

Other process connections and seals on request.

Further details on: Process connection	
Max. measuring range	→ See table "Process connection"
Overpressure limit	→ See table „Process connection“
Seal	→ See table "Process connection"
Pressure port diameter	→ See table "Process connection"
Possible restrictions	Depending on the choice of seal at the process connection, there may be restrictions in the permissible temperature range
NBR	-30 ... +100 °C [-22 ... + 212 °F]
FPM/FKM	-40 ... +200 °C [-40 ... +392 °F]
EPDM	-40 ... +125 °C [-40 ... +257 °F]
Copper	-40 ... +200 °C [-40 ... +392 °F]
Stainless steel	-40 ... +200 °C [-40 ... +392 °F]

Output signal		
Signal type		
Current (2-wire)	<ul style="list-style-type: none"> ■ 4 ... 20 mA ■ 20 ... 4 mA 	
Voltage (3-wire)	<ul style="list-style-type: none"> ■ DC 0 ... 10 V ■ DC 0 ... 5 V ■ DC 1 ... 5 V ■ DC 0.5 ... 4.5 V ■ DC 1 ... 6 V ■ DC 10 ... 0 V 	
Ratiometric (3-wire)	DC 0.5 ... 4.5 V	
Load		
Current (2-wire)	$\leq (\text{auxiliary power} - 7.5 \text{ V}) / 0.023 \text{ A}$	
Voltage (3-wire)	$> \text{maximum output signal} / 1 \text{ mA}$	
Ratiometric (3-wire)	$> 4.5\text{k}$	
Signal damping	See table "Further details on: Output signal"	
Signal clamping		
Output signal 4 ... 20 mA	Zero point	<ul style="list-style-type: none"> ■ 3.6 mA ■ 3.8 mA ■ 4.0 mA
	Full scale	<ul style="list-style-type: none"> ■ 20 mA ■ 21.5 mA ■ 23 mA
Output signal DC 0 ... 10 V	Full scale	<ul style="list-style-type: none"> ■ DC 10 V ■ DC 11.5 V
Voltage supply		
Auxiliary power	Output signal 4 ... 20 mA	DC 8 ... 36 V
	Output signal 20 ... 4 mA	DC 8 ... 36 V
	Output signal DC 0 ... 10 V	DC 12 ... 36 V
	Output signal DC 0 ... 5 V	DC 8 ... 36 V
	Output signal DC 1 ... 5 V	DC 8 ... 36 V
	Output signal DC 0.5 ... 4.5 V	DC 8 ... 36 V
	Output signal DC 1 ... 6 V	DC 9 ... 36 V
	Output signal DC 10 ... 0 V	DC 12 ... 36 V
	Output signal DC 0.5 ... 4.5 V ratio	DC 5 V \pm 10 %

Output signal		
Current supply	Current (2-wire)	Signal current, max. 25 mA
	Voltage (3-wire)	Max. 12 mA
Dissipation loss	Current (2-wire)	828 mW (22 mW/K derating of dissipation loss at ambient temperatures $\geq 100\text{ }^{\circ}\text{C}$ [212 $^{\circ}\text{F}$])
	Voltage (3-wire)	432 mW
Overvoltage resistance	DC 40 V → Not for ratiometric output signals	
Dynamic behaviour		
Settling time per IEC 61298-2	→ See table "Further details on: Output signal"	
Switch-on time	150 ms	
Start-up drift	5 s (60 s with optional zero point adjustment 0.1 %)	

Further details on: Output signal			
Signal type	Settling time per IEC 61298-2		Signal damping
	3 dB limit frequency 500 Hz	3 dB limit frequency 1,000 Hz ¹⁾	
Current (2-wire)	3 ms	1 ms	<ul style="list-style-type: none"> ■ 10 ms ■ 50 ms ■ 100 ms ■ 500 ms ■ 1,000 ms ■ 2,500 ms ■ 5,000 ms
Voltage (3-wire)	2 ms	1 ms	
Ratiometric (3-wire)	2 ms	1 ms	

1) Alternative specifications for 4 ... 20 mA output signal:
 Load: \leq (auxiliary power - 11.5 V) / 0.023 A
 Auxiliary power: DC 12 ... 36 V

Other output signals on request.

Electrical connection					
Connection type	IP code ¹⁾	Wire cross-section	Cable diameter	Cable material	Permissible temperature
Angular connector DIN EN 175301-803 A ²⁾					
With mating connector	IP65	Max. 1.5 mm ²	6 ... 8 mm	-	-30 ... +100 °C [-22 ... +212 °F]
With mating connector (conduit)	IP65	Max. 1.5 mm ²	-	-	-30 ... +100 °C [-22 ... +212 °F]
With mating connector with moulded cable	IP65	3 x 0.75 mm ²	6 mm	PUR	-30 ... +100 °C (cULus: -25 ... +85 °C) [-22 ... +212 °F (cULus: -4 ... +185 °F)]
With mating connector with moulded cable, shielded	IP65	6 x 0.5 mm ²	6.8 mm	PUR	-25 ... +85 °C [-4 ... +185 °F]
Angular connector DIN EN 175301-803 C ²⁾					
With mating connector	IP65	Max. 0.75 mm ²	4.5 ... 6 mm	-	-30 ... +100 °C [-22 ... +212 °F]
Circular connector M12 x 1, 4-pin ²⁾					
Without mating connector	IP67	-	-	-	-30 ... +100 °C [-22 ... +212 °F]
With straight mating connector with moulded cable	IP67	3 x 0.34 mm ²	4.3 mm	PUR	-25 ... +80 °C [-4 ... +176 °F]
With straight mating connector with moulded cable, shielded	IP67	3 x 0.34 mm ²	4.3 mm	PUR	-25 ... +80 °C [-4 ... +176 °F]
With angled mating connector with moulded cable	IP67	3 x 0.34 mm ²	5.5 mm	PUR	-25 ... +80 °C [-4 ... +176 °F]
Circular connector M12 x 1, 4-pin, metal					

Electrical connection					
Connection type	IP code ¹⁾	Wire cross-section	Cable diameter	Cable material	Permissible temperature
Without mating connector	IP67	-	-	-	-40 ... +125 °C (cULus: +85 °C) [-40 ... +257 °F (cULus: +185 °F)]
With straight mating connector with moulded cable	IP67	3 x 0.34 mm ²	4.3 mm	PUR	-25 ... +80 °C [-4 ... +176 °F]
With straight mating connector with moulded cable, shielded	IP67	3 x 0.34 mm ²	4.3 mm	PUR	-25 ... +80 °C [-4 ... +176 °F]
With angled mating connector with moulded cable	IP67	3 x 0.34 mm ²	5.5 mm	PUR	-25 ... +80 °C [-4 ... +176 °F]
Bayonet connector, 6-pin	IP67	-	-	-	-40 ... +125 °C [-40 ... +257 °F]
Field case	IP6K9K	-	7 ... 13 mm	-	-25 ... +100 °C [-4 ... +212 °F]
Cable outlet					
Cable outlet IP67 ¹⁾	IP67	3 x 0.34 mm ²	5.5 mm	PUR	-30 ... +100 °C [-22 ... +212 °F]
Cable outlet ½ NPT conduit	IP67	6 x 0.35 mm ²	6.1 mm	PUR	-30 ... +100 °C (cULus: +90 °C) [-22 ... +212 °F (cULus: +194 °F)]
Cable outlet IP68	IP68	6 x 0.35 mm ²	6.1 mm	PUR	-30 ... +125 °C (cULus: +90 °C) [-22 ... +257 °F (cULus: +194 °F)]
Cable outlet IP68, FEP	IP68	6 x 0.39 mm ²	5.8 mm	FEP	-40 ... +125 °C (cULus: +105 °C) [-40 ... +257 °F (cULus: +221 °F)]
Cable outlet IP6K9K	IP6K9K	6 x 0.35 mm ²	6.1 mm	PUR	-30 ... +125 °C (cULus: +90 °C) [-22 ... +257 °F (cULus: +194 °F)]

1) The stated IP codes only apply when plugged in using mating connectors that have the appropriate IP code.

2) Customer zero point adjustment available as an option.

Other connections on request.

Further details on: Electrical connection	
Connection type	→ See table "Electrical connection"
Wire cross-section	→ See table "Electrical connection"
Cable diameter	→ See table "Electrical connection"
Pin assignment	→ See "Pin assignment"
Ingress protection (IP code) per IEC 60529	→ See table "Electrical connection"
Cable length	<ul style="list-style-type: none"> ■ 2 m ■ 5 m ■ 6 ft ■ 15 ft
Assembly of the cable outlets	
Cable outlet IP67	<ul style="list-style-type: none"> ■ Unfinished wire ends ■ Tinned wire ends ■ With end splices
Cable outlet ½ NPT conduit	<ul style="list-style-type: none"> ■ With end splices ■ Tinned wire ends
Cable outlet IP68	<ul style="list-style-type: none"> ■ With end splices ■ Tinned wire ends
Cable outlet IP68, FEP	<ul style="list-style-type: none"> ■ With end splices ■ Tinned wire ends
Cable outlet IP6K9K	<ul style="list-style-type: none"> ■ With end splices ■ Tinned wire ends
Short-circuit resistance	<p>S₊ vs. U.</p> <p>→ Not for ratiometric output signals</p>

Further details on: Electrical connection

Reverse polarity protection

U₊ vs. U.
→ No reverse polarity protection with ratiometric output signal

Insulation voltage

DC 750 V

Other cable lengths on request.

Pin assignment

Angular connector DIN 175301-803 A

		2-wire	3-wire
	U ₊	1	1
	U ₋	2	2
	S ₊	-	3
	Shield (option)	4	4

Circular connector M12 x 1 (4-pin)

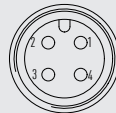
		2-wire	3-wire
	U ₊	1	1
	U ₋	3	3
	S ₊	-	4
	Shield (option)	Case	Case

Angular connector DIN 175301-803 C

		2-wire	3-wire
	U ₊	1	1
	U ₋	2	2
	S ₊	-	3
	Shield (option)	4	4

Field case

		2-wire	3-wire
	U ₊	1	1
	U ₋	2	2
	S ₊	-	3
	Shield	5	5

Bayonet connector (6-pin)

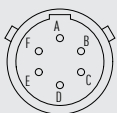
		2-wire	3-wire
	U ₊	A	A
	U ₋	B	B
	S ₊	-	C
	Shield	Case	Case

Legend

U₊ Positive power supply terminal
U₋ Negative power supply terminal
S₊ Analogue output

Other pin assignments on request.

Cable outlet

		2-wire	3-wire
	U ₊	Brown (BN)	Brown (BN)
	U ₋	Blue (BU)	Blue (BU)
	S ₊	-	Black (BK)
	Shield ¹⁾	Grey (GY)	Grey (GY)

1) With cable outlet IP67 and cable outlet ½ NPT conduit, the shield is optional

Mating connector with moulded cable

		2-wire	3-wire
	U ₊	Brown (BN)	Brown (BN)
	U ₋	Blue (BU)	Blue (BU)
	S ₊	-	Black (BK)

Material		
Material (wetted)		
Relative measuring ranges	Measuring ranges ≤ 10 bar [150 psi]	316L
	Measuring ranges > 10 bar [150 psi]	316L + PH grade steel
	Measuring ranges > 1,000 bar [10,000 psi]	ASTM 630 and PH grade steel
Absolute pressure measuring ranges	316L	
Sealing materials	→ See table "Process connection"	
Material (in contact with the environment)		
Case	316 Ti	
Electrical connection	Angular connector DIN 175301-803 A	PBT/PET GF30
	Angular connector DIN 175301-803 C	PBT/PET GF30
	Circular connector M12 x 1, 4-pin	PBT/PET GF30
	Circular connector M12 x 1, 4-pin, metal	316L
	Bayonet connector, 6-pin	316L + Al
	Field case	316L, 316Ti, nickel-plated brass
	Cable outlet IP67	PA66, PBT/PET GF30
	Cable outlet ½ NPT conduit	316L
	Cable outlet specification IP68	316L
	Cable outlet specification IP68, FEP	316L
Pressure transmission medium	< 10 bar [150 psi]	Synthetic oil
	≥ 10 bar [150 psi]	Dry measuring cell
	≤ 40 bar abs. [580 psi abs.]	Synthetic oil

Operating conditions		
Medium temperature limit	Ambient temperature limit	Notes
-30 ... +100 °C [-22 ... +212 °F]	-30 ... +100 °C [-22 ... +212 °F]	-
-40 ... +125 °C [-40 ... +257 °F]	-40 ... +125 °C [-40 ... +257 °F]	-
-40 ... +150 °C [-40 ... +302 °F]	-40 ... +125 °C [-40 ... +257 °F] ¹⁾	400 bar [5,800 psi] With integrated cooling element
-40 ... +200 °C [-40 ... +392 °F]	-40 ... +125 °C [-40 ... +257 °F] ¹⁾	400 bar [5,800 psi] With integrated cooling element
-20 ... +60 °C [-4 ... +140 °F]	-20 ... +60 °C [-4 ... +140 °F]	Oxygen version

1) Derating curve and formula (see following diagram)

Derating curve for cooling elements

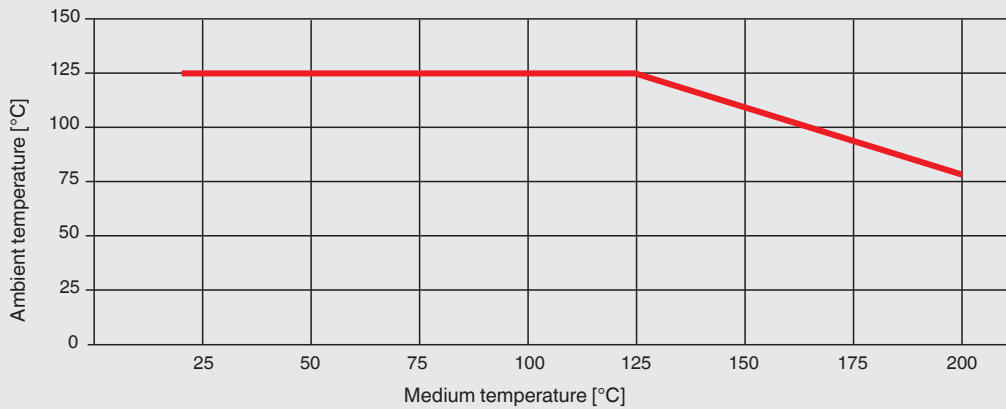

Maximum permissible ambient temperature

$$T_{amb} (T_{med} < 125 \text{ °C}) = 125 \text{ °C}$$

$$T_{amb} (T_{med} \geq 125 \text{ °C}) = -0.62 \times T_{med} + 202 \text{ °C}$$

Maximum permissible medium temperature

$$T_{med} (T_{amb} < 80 \text{ °C}) = 200 \text{ °C}$$

$$T_{med} (T_{amb} \geq 80 \text{ °C}) = -1.61 \times T_{amb} + 326 \text{ °C}$$

T_{amb} = ambient temperature [°C]

T_{med} = medium temperature [°C]

Depending on the choice of seal on the process connection and the electrical connection, there may be restrictions in the medium and ambient temperature (for restrictions, see “Process connection” and “Electrical connection”).

Further details on: Operating conditions

Storage temperature limit	-40 ... +70 °C [-40 ... +158 °F]
Vibration resistance per IEC 60068-2-6	20g, 10 ... 2,000 Hz
	40g, 10 ... 2,000 Hz for circular connector M12 x 1, metal
	10g, 10 ... 2,000 Hz for instruments with cooling element
Shock resistance per IEC 60068-2-27	100g, 6 ms
	500g, 1 ms for circular connector M12 x 1, metal
Ingress protection (IP code) per IEC 60529	→ See “Electrical connection”
Service life	
Measuring ranges < 600 bar [7,500 psi]	100 million load cycles
Measuring ranges ≥ 600 bar [7,500 psi]	10 million load cycles







Options for specific media

Food	Food-compatible transmission fluid	
Oil- and grease-free		
Residual hydrocarbon	< 1,000 mg/m ²	
Packaging	Protection cap on the process connection	
Oxygen, oil- and grease-free		
Residual hydrocarbon	Measuring ranges < 30 bar [435 psi]	< 500 mg/m ²
	Measuring ranges > 30 bar [435 psi]	< 200 mg/m ²
Packaging	Protection cap on the process connection	
Medium temperature limit	-20 ... +60 °C [-4 ... +140 °F]	

Options for specific media		
Max. measuring range	400 bar [5,800 psi]	
Overpressure limit	2 times	
Influence of mounting position (measuring ranges ≤ 1 bar)	Mounting position 180°, vertical, top process connection	≤ 1.4 mbar [≤ 0.02 psi]
	Mounting position 90°, horizontal, lateral process connection	≤ 0.8 mbar [≤ 0.012 psi]
Hydrogen, oil- and grease-free		
Measuring ranges	≥ 25 bar [≥ 362 psi]	
Material (wetted)	316L and Elgiloy® (2.4711)	
Residual hydrocarbon	$< 1,000$ mg/m ²	
	→ For further information, see technical information IN 00.40 on the website.	

Packaging and instrument labelling	
Packaging	Individual packaging
Instrument labelling	<ul style="list-style-type: none"> ■ WIKA product label, lasered ■ Customer-specific product label on request

Approvals

Logo	Description	Country
	EU declaration of conformity	European Union
	EMC directive	
	Pressure Equipment Directive	
	RoHS directive	
	UL Safety (e.g. electr. safety, overpressure, ...)	USA and Canada
	EAC EMC directive	Eurasian Economic Community
	KazInMetr Metrology, measurement technology	Kazakhstan
-	MTSCHS Permission for commissioning	Kazakhstan
	UkrSEPRO Metrology, measurement technology	Ukraine
	Uzstandard Metrology, measurement technology	Uzbekistan
-	CRN Safety (e.g. electr. safety, overpressure, ...)	Canada

Manufacturer's information

Logo	Description
-	China RoHS directive
MTTF	> 100 years

Test report

Test report	
Non-linearity 0.5 %	3 measuring points
Non-linearity 0.25 %	5 measuring points
Non-linearity 0.125 %	5 measuring points

Certificates (option)

Certificates	
Certificates	<ul style="list-style-type: none"> ■ 2.2 test report per EN 10204 (e.g. state-of-the-art manufacturing, material proof, indication accuracy) ■ 3.1 inspection certificate per EN 10204 (e.g. material proof for wetted metal parts, indication accuracy, calibration certificate)
Calibration	<ul style="list-style-type: none"> ■ Factory calibration certificate ■ DAkkS calibration certificate (traceable and accredited in accordance with ISO/IEC 17025)
Recommended calibration interval	1 year (dependent on conditions of use)

→ For approvals and certificates, see website

Dimensions in mm [in]

With angular connector DIN EN 175301-803
A

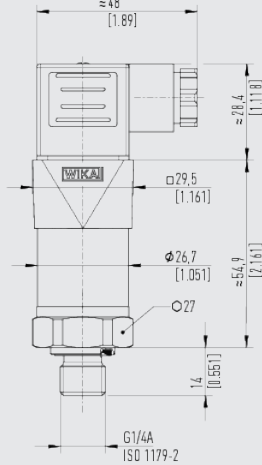

Weight: approx. 150 g [0.331 lb]

With circular connector M12 x 1 (4-pin)

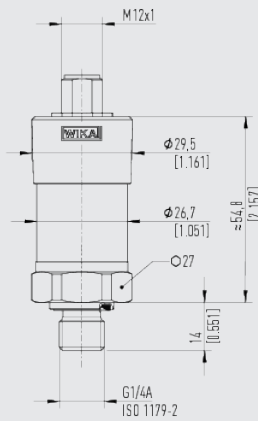

Weight: approx. 150 g [0.331 lb]

With circular connector M12 x 1
(4-pin, metallic)

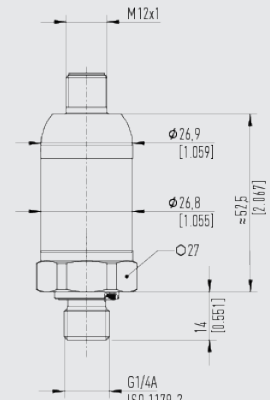

Weight: approx. 150 g [0.331 lb]

With bayonet connector (6-pin)

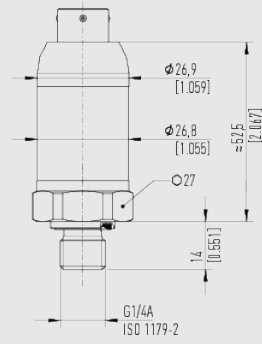

Weight: approx. 150 g [0.331 lb]

With angular connector DIN EN 175301-803
C

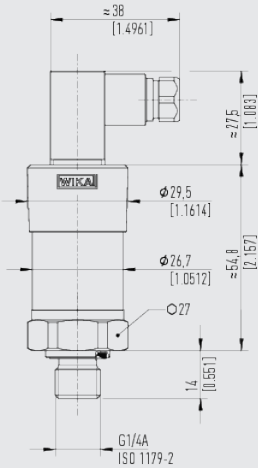

Weight: approx. 150 g [0.331 lb]

With field case

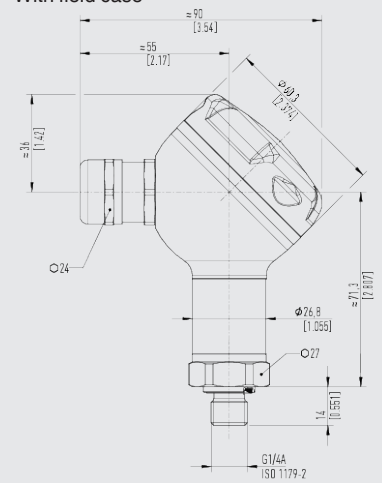

Weight: approx. 290 g [0.639 lb]

With cable outlet IP68, FEP, IP6K9K

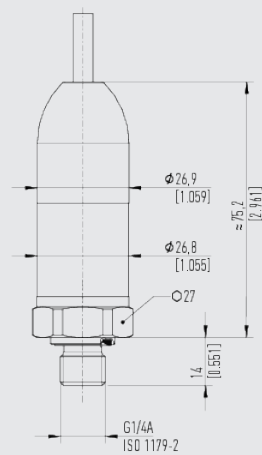

Weight: approx. 220 g [0.485 lb]

With cable outlet 1/2 NPT conduit

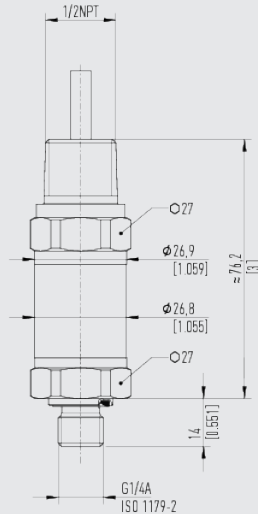

Weight: approx. 220 g [0.485 lb]

Dimensions in mm [in]

With angular connector DIN 175301-803 A and cooling element

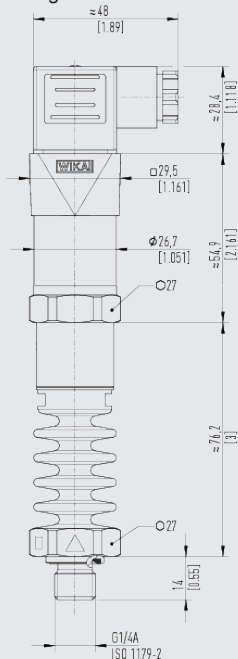

Weight: approx. 360 g [0.794 lb]

With cable outlet IP67

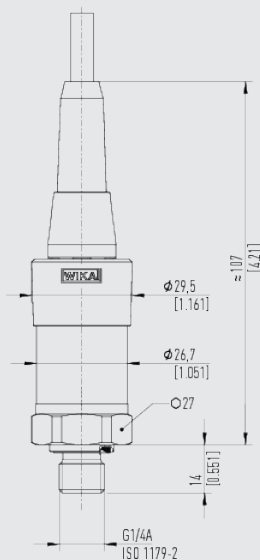

Weight: approx. 150 g [0.331 lb]

Process connections

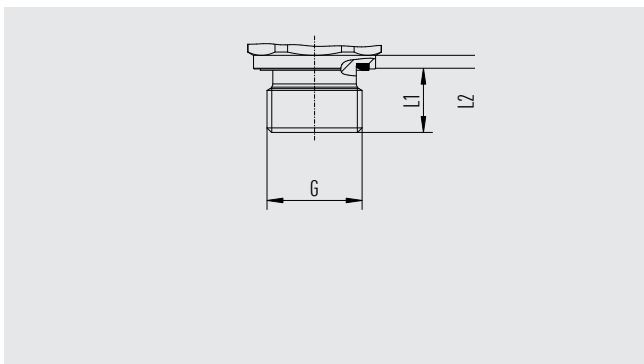

G	L1	L2
M14 x 1.5 DIN EN ISO 9974-2	12 [0.47]	2 [0.08]

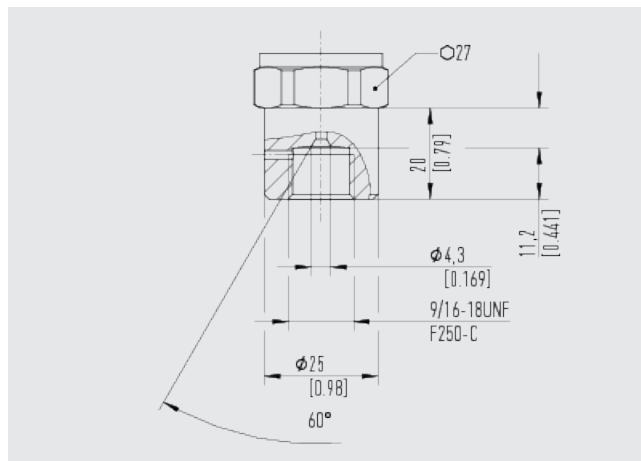

→ For information on process connections, see technical information IN 00.14 at www.wika.com.

Accessories and spare parts

Description	Version	Order number
Mating connector		
Angular connector DIN 175301-803 A	Gland PG9	11427567
	With 2 m cable	11225793
	With 2 m cable, shielded	14100465
	With 5 m cable	11250186
	Conduit ½ NPT	11022485
Angular connector DIN 175301-803 C	Gland PG7	1439081
Circular connector M12 x 1, 4-pin, straight	With 2 m cable	11250780
	With 5 m cable	11250259
	With 2 m cable, shielded	14056584
Circular connector M12 x 1, 4-pin, angled	With 2 m cable	11250798
	With 5 m cable	11250232
Seals for mating connector		
Angular connector DIN EN 175301-803 A	Blue (WIKA)	1576240
	Brown (neutral)	11437902
Angular connector DIN 175301-803 C	Blue (WIKA)	11169479
	Brown (neutral)	11437881
Seals for process connection		
G ⅛ B EN 837	Copper	11251051
G ¼ B EN 837	Copper	11250810
	Stainless steel	11250844
G ⅜ B EN 837	Copper	11250861
G ½ B EN 837	Copper	11250861
	Stainless steel	11251042
G ¼ A DIN EN ISO 1179-2	NBR	1537857
	FKM/FPM	1576534
G ½ A DIN EN ISO 1179-2	NBR	1039067
	FKM	1039075
M14 x 1.5 DIN EN ISO 9974-2	NBR	1537857
	FKM	1576534
M12 x 1.5 DIN 16288	Copper	11250810
	Stainless steel	11250844
M20 x 1.5 DIN 16288	Copper	11250861
	Stainless steel	11251042
7/16-20 UNF BOSS SAE J514	NBR	14057554
	FKM	11472022
9/16-18 UNF BOSS SAE J514	NBR	14057555
	FKM	2063240

→ Only use the accessories listed above, otherwise it could lead to the loss of the approval.

Ordering information

Model / Measuring range / Overpressure limit / Output signal / Non-linearity / Adjustment temperature / Zero point setting / Process connection / Pressure port / Seal / Electrical connection / Assembly / Cable length / Shielding / Certificates / Packaging / Instrument labelling / Accessories and spare parts

© 04/2013 WIKA Alexander Wiegand SE & Co. KG, all rights reserved.
The specifications given in this document represent the state of engineering at the time of publishing.
We reserve the right to make modifications to the specifications and materials.
In case of a different interpretation of the translated and the English data sheet, the English wording shall prevail.

