

# Bourdon tube pressure gauge with electrical output signal

## Stainless steel, safety version, NS 100 and 160

### Models PGT23.100 and PGT23.160

WIKA data sheet PV 12.04



For further approvals,  
see page 4

**intelliGAUGE®**

### Applications

- Acquisition and display of processes
- Output signal 4 ... 20 mA for the transmission of process values to the control room
- Easy-to-read, analogue on-site display needing no external power
- Process industry: Chemical industry, petrochemical industry, oil and gas, power generation, water and wastewater

### Special features

- No configuration necessary due to “plug-and-play”
- Signal transmission per NAMUR
- Measuring ranges 0 ... 0.6 bar to 0 ... 1,600 bar
- Safety version S3 per EN 837
- QR code on dial links to instrument-specific information

**intelliGAUGE® model PGT23.100**

### Description

Wherever the process pressure has to be indicated locally and, at the same time, a signal transmission to the central control or remote centre is desired, the model PGT23 intelliGAUGE® (patent, property right: e.g. DE 202007019025) can be used.

Through the combination of a mechanical measuring system and electronic signal processing, the process pressure can be read securely, even if the voltage supply is lost. The intelliGAUGE model PGT23 fulfils all safety-related requirements of the relevant standards and regulations for the on-site display of the working pressure of pressure vessels. An additional measuring point for mechanical pressure display can thus be saved. The model PGT23 is based upon a model 23X.30 high-quality, stainless steel safety pressure gauge.

The all welded and robust Bourdon tube measuring system produces a pointer rotation proportional to the pressure. An electronic angle encoder, proven in safety-critical automotive applications, determines the position of the pointer shaft – it is a non-contact sensor and therefore completely free from wear and friction. From this, the electrical output signal proportional to the pressure, 4 ... 20 mA, is produced.

The electronic WIKA sensor, integrated into the high-quality pressure gauge, combines the advantages of electrical signal transmission with the advantages of a local mechanical display.

The QR code on the dial allows instrument-specific information such as the serial number, the order number, certificates and other product data to be retrieved from the internet easily and in the long term.

## Specifications

Models PGT23.100 and PGT23.160	
Nominal size in mm	<ul style="list-style-type: none"> <li>■ 100</li> <li>■ 160</li> </ul>
Accuracy class	1.0
Scale ranges	0 ... 0.6 bar [0 ... 8.7 psi] to 0 ... 1,600 bar [0 ... 23,206 psi] other units (e.g. psi, kpa) available or all other equivalent vacuum or combined pressure and vacuum ranges
Scale	Single scale Option: Dual scale
Pressure limitation	
Steady	Full scale value
Fluctuating	0.9 x full scale value
Short time	1.3 x full scale value
Connection location	<ul style="list-style-type: none"> <li>■ Lower mount (radial)</li> <li>■ Lower back mount</li> </ul>
Process connection	<ul style="list-style-type: none"> <li>■ G ½ B</li> <li>■ ½ NPT</li> <li>■ M20 x 1.5</li> </ul> others on request
Permissible temperature <sup>1)</sup>	
Medium	-40 ... +100 °C [-40 ... 212 °F] maximum
Ambient	-40 ... +60 °C [-40 ... 284 °F]
Temperature effect	When the temperature of the measuring system deviates from the reference temperature (+20 °C): max. ±0.4 %/10 K of full scale value
Case	Safety version S3 per EN 837: With solid baffle wall (Solidfront) and blow-out back
Case filling	Without Option: With case filling
Wetted materials	
Process connection, pressure element	Stainless steel 316L, option: Monel
Non-wetted materials	
Case, bayonet ring	Stainless steel
Movement	Brass
Dial	Aluminium, white, black lettering
Instrument pointer	Aluminium, black
Set pointer	Aluminium, red
Window	Laminated safety glass
Ingress protection per IEC/EN 60529	IP65 <sup>2)</sup> Option: IP66

1) For hazardous areas, the permissible temperatures of the output signal variant 2 will apply exclusively (see page 3). These must not be exceeded at the instrument either (for details see operating instructions). If necessary, measures for cooling (e.g. syphon, instrumentation valve, etc.) have to be taken.

2) Ingress protection IP54 with lower back mount.

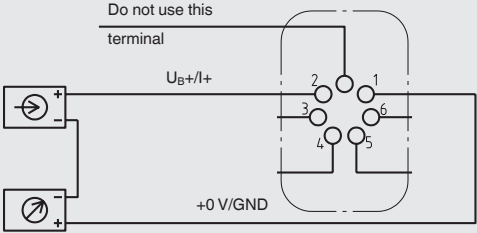
Models PGT23.100 and PGT23.160	
<b>Output signal</b>	Variant 1: 4 ... 20 mA, 2-wire, passive, per NAMUR NE 43 Variant 2: 4 ... 20 mA, 2-wire, for hazardous areas Variant 3: 0 ... 20 mA, 3-wire Variant 4: 0 ... 10 V, 3-wire
<b>Auxiliary power <math>U_B</math></b>	DC 12 V < $U_B$ ≤ 30 V (variant 1 and 3) DC 14 V < $U_B$ ≤ 30 V (variant 2) DC 15 V < $U_B$ ≤ 30 V (variant 4)
<b>Influence of auxiliary power</b>	≤ 0.1 % of full scale/10 V
<b>Permissible residual ripple of <math>U_B</math></b>	≤ 10 % ss
<b>Permissible max. load <math>R_A</math></b>	Variant 1, 2, 3: $R_A \leq (U_B - 12 \text{ V})/0.02 \text{ A}$ with $R_A$ in $\Omega$ and $U_B$ in V, however max. 600 $\Omega$ Variant 4: $R_A = 100 \text{ k}\Omega$
<b>Effect of load (variant 1, 2, 3)</b>	≤ 0.1 % of full scale
<b>Impedance at voltage output</b>	0.5 $\Omega$
<b>Electrical zero point</b>	Through a jumper across terminals 5 and 6 (see operating instructions)
Long-term stability of electronics	< 0.3 % of full scale per year
Electr. output signal	≤ 1 % of measuring span
<b>Linear error</b>	≤ 1 % of measuring span (terminal method)
<b>Resolution</b>	0.13 % of full scale (10 bit resolution at 360°)
<b>Refresh rate (measuring rate)</b>	600 ms
<b>Electrical connection</b>	Cable socket PA 6, black Per VDE 0110 insulation group C/250 V Cable gland M20 x 1.5 Strain relief 6 screw terminals + PE for conductor cross-section 2.5 mm <sup>2</sup>
<b>Designation of connection terminals, 2-wire (variant 1 and 2)</b>	 <p>Do not use this terminal</p> <p><math>U_B+/I+</math></p> <p><math>+0 \text{ V/GND}</math></p> <p>Terminals 3 and 4: For internal use only Terminals 5 and 6: Reset zero point</p>
Designation of connection terminals for 3-wire (variant 3 and 4), see operating instructions	

### Safety-related maximum values (variant 2)

$U_i$	$I_i$	$P_i$	$C_i$	$L_i$
DC 30 V	100 mA	720 mW	11 nF	negligible



### Permissible temperature ranges (variant 2)

T6	T5	T4 ... T1
-20 ... +45 °C	-20 ... +60 °C	-20 ... +70 °C









T85°C	T100°C	T135°C
-20 ... +45 °C	-20 ... +60 °C	-20 ... +70 °C

For further information on hazardous areas, see operating instructions.

## Approvals

Logo	Description	Region
	<b>EU declaration of conformity</b>	European Union
	EMC directive	
	Low Voltage Directive	
	RoHS directive	
	<b>UKCA</b> Pressure equipment (safety) regulations	United Kingdom
-	<b>CRN</b> Safety (e.g. electr. safety, overpressure, ...)	Canada

## Optional approvals

Logo	Description	Region
 	<b>EU declaration of conformity</b>	European Union
	ATEX directive Hazardous areas	
	Gas II 2G Ex ia IIC T6/T5/T4 Gb	
	Dust II 2D Ex ia IIIB T135°C Db	
 	<b>IECEx</b> Hazardous areas	International
Gas Ex ia IIC T6/T5/T4 Gb		
Dust Ex ia IIIB T135°C Db		
	<b>EAC</b>	Eurasian Economic Community
	EMC directive	
	Low voltage directive	
	Hazardous areas	
	<b>Ex Ukraine</b> Hazardous areas	Ukraine
	<b>NEPSI</b> Hazardous areas	China
-	<b>MChS</b> Permission for commissioning	Kazakhstan
	<b>PAC Uzbekistan</b> Metrology, measurement technology	Uzbekistan

## Certificates (option)

Certificates	
<b>Certificates</b>	<ul style="list-style-type: none"> <li>■ 2.2 test report per EN 10204 (e.g. state-of-the-art manufacturing, indication accuracy)</li> <li>■ 3.1 inspection certificate per EN 10204 (e.g. indication accuracy)</li> </ul>
<b>Recommended calibration interval</b>	1 year (dependent on conditions of use)

## Patents, property rights

Patent number	Description
DE 202007019025, US 2010045366, CN 101438333	Pointer measuring instrument with output signal

→ Approvals and certificates, see website

# Dimensions in mm

intelliGAUGE® models PGT23.100 and PGT23.160

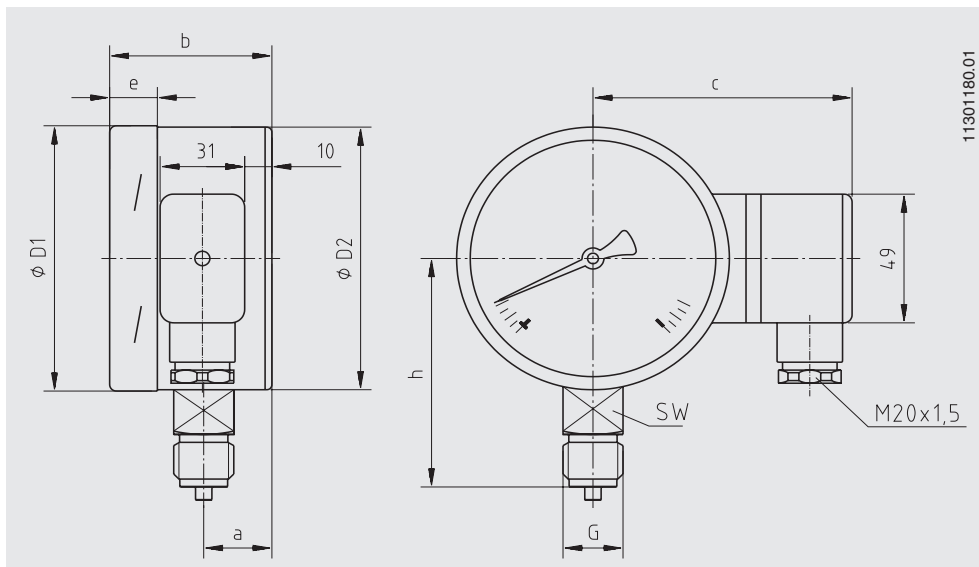

NS	Dimensions in mm									Weight in kg
	a	b	c	D <sub>1</sub>	D <sub>2</sub>	e	G	h ±1	SW	
100	25	59.5	94	101	100	17	G ½ B	87	22	0.80
160	27	59.5	123.5	161	159	17.5	G ½ B	118	22	1.45

## Accessories

- Panel mounting flange, polished stainless steel
- Surface mounting flange, stainless steel
- Sealings (model 910.17, see data sheet AC 09.08)
- Valves (model IV2, see data sheet AC 09.19, and model IV1, see data sheet AC 09.22)
- Syphons (model 910.15, see data sheet AC 09.06)
- Overpressure protector (model 910.13, see data sheet AC 09.04)
- Cooling element (model 910.32, see data sheet AC 09.21)
- Diaphragm seal
- For further information on switch contacts, see technical information IN 00.48

## Ordering information

Model / Nominal size / Scale range / Output signal / Connection location / Process connection / Options

© 11/2007 WIKA Alexander Wiegand SE & Co. KG, all rights reserved.  
The specifications given in this document represent the state of engineering at the time of publishing.  
We reserve the right to make modifications to the specifications and materials.  
In case of a different interpretation of the translated and the English data sheet, the English wording shall prevail.

