

Resistance thermometer For additional thermowell Model TR10-B

WIKA data sheet TE 60.02



For further approvals,
see page 18

Applications

- Machine building, plant and vessel construction
- Energy and power plant technology
- Chemical industry
- Food and beverage industry
- Sanitary, heating and air-conditioning technology

Special features

- Sensor ranges from -196 ... +600 °C [-320 ... +1,112 °F]
- For mounting in all standard thermowell designs
- Spring-loaded measuring insert (replaceable)
- Pt100 or Pt1000 sensors
- Explosion-protected versions are available for many approval types



Fig. left: model TR10-B with BSZ connection head

Fig. centre: model TR10-B with 1/4000 connection head

Fig. right: model TR10-B with PIH-L connection head

Description

Resistance thermometers in this series can be combined with a large number of thermowell / protection tube designs. Operation without thermowell / protection tube is only recommended in certain applications.

A wide variety of possible combinations of Pt100 or Pt1000 sensor, connection head, insertion length, neck length, connection to thermowell etc. are available for the thermometers; suitable for any thermowell dimension and any application.

A large number of different explosion-protected approvals are available for the TR10-B.

It is possible to mount analogue or digital WIKA transmitters in the connection head of the TR10-B.

Representation of the components

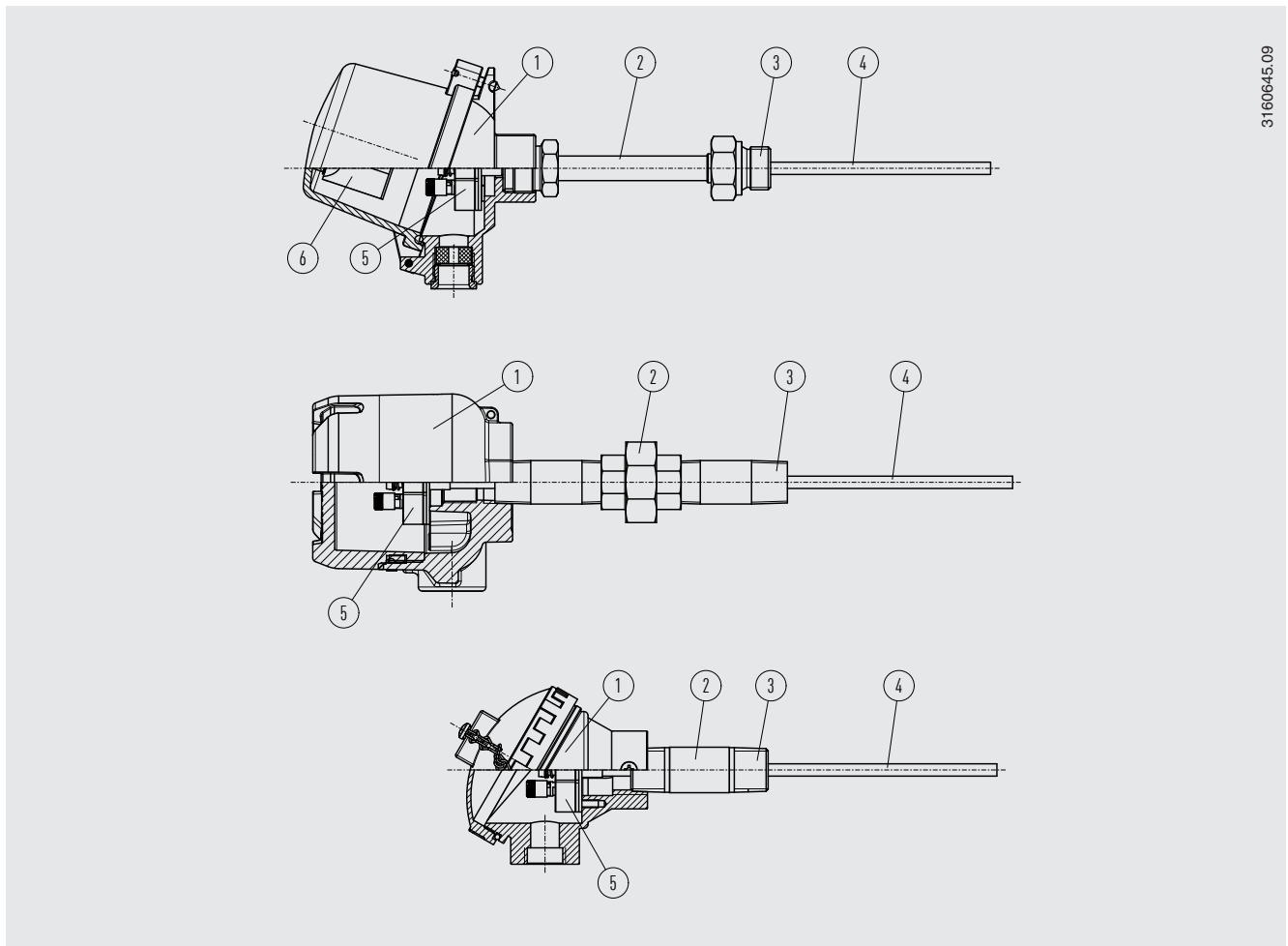

3160645.09

Legend:

- ① Connection head
- ② Neck tube
- ③ Connection to thermowell
- ④ Measuring insert (TR10-A)
- ⑤ Terminal block/transmitter (option)
- ⑥ Transmitter (option)

Overview of approvals for explosion protection

Approval	Explosion protection				
	Ex i (gas) Zone 0, 1, 2	Ex i (dust) Zone 20, 21, 22	Ex e (gas) Zone 1, 2	Ex t (dust) Zone 21, 22	Ex nA (gas) Zone 2
ATEX	x	x	x	x	x
IECEX	x	x	x	x	x
ECASEX	-	-	x	x	x
EACEX	x	x	x	x	x
Ex Ukraine	x	x	-	-	-
INMETRO	x	x	-	-	-
CCC	x	x	x	x	-
NEPSI	x	x	-	-	-
KCs	x	-	-	-	-
PESO	x	-	-	-	-

→ For detailed information, see "Approvals" on page 18

Measuring element

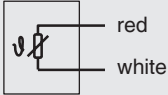
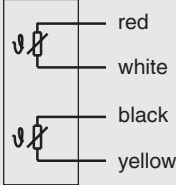
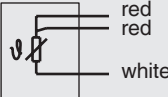
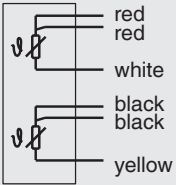
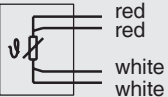
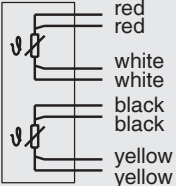
Measuring element			
Type of measuring element		Pt100, Pt1000	
Measuring current		0.1 ... 1.0 mA	
Connection method			
Single elements		Dual elements	
1 x 2-wire		2 x 2-wire	
1 x 3-wire		2 x 3-wire	
1 x 4-wire		2 x 4-wire ¹⁾	
Validity limits of the class accuracy in accordance with IEC 60751			
Class B $\pm (0.30 + 0.0050 t)$ ³⁾		<ul style="list-style-type: none"> ■ -196 ... +600 °C [-321 ... +1112 °F] ■ -196 ... +450 °C [-321 ... +842 °F] ■ -50 ... +500 °C [-58 ... +932 °F] ■ -50 ... +250 °C [-58 ... +482 °F] 	
Class A ²⁾ $\pm (0.15 + 0.0020 t)$ ³⁾		<ul style="list-style-type: none"> -100 ... +450 °C [-148 ... +842 °F] -30 ... +300 °C [-22 ... +572 °F] 	
Class AA ²⁾ $\pm (0.10 + 0.0017 t)$ ³⁾		<ul style="list-style-type: none"> -50 ... +250 °C [-58 ... +482 °F] 0 ... 150 °C [32 ... 302 °F] 	

1) Not for 3 mm [0.118 in] diameter and 1/8 in [3.2 mm] diameter

2) Not for 2-wire connection method

3) | t | is the numerical value of the temperature in °C without consideration of the sign

→ For detailed specifications for Pt100 sensors, see technical information IN 00.17 at www.wika.com.

The table shows the temperature ranges listed in the respective standards, in which the tolerance values (class accuracies) are valid.

- The combinations of a 2-wire connection with class A or class AA are not permissible, since the lead resistance of the MIMS cable and the connection lead negates the higher sensor accuracy.

Maximum probe length including connection cable:





- Class B, 3-wire connection: ~ 30 m [98 ft]
- Class A, 3-wire connection: ~ 10 m [33 ft]
- Class AA, 3-wire connection: ~ 3 m [10 ft]

- Longer probe/cable lengths should be designed with a 4-wire connection, since this connection method has no length effect on the accuracy.

- The use of TR10-B with a Pt100 sensor in a 2-wire connection is technically feasible, of course, but not recommended due to the lead resistance problem.

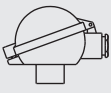
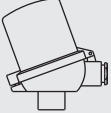
Connection head

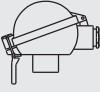
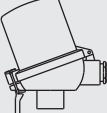
■ European designs per EN 50446 / DIN 43735

Model	Material	Cable inlet thread size	Ingress protection (max.) 1) 2) IEC/EN 60529	Cap	Surface	Connection to neck tube
	BSZ	Aluminium	■ M20 x 1.5 ■ ½ NPT	IP65	Spherical hinged cover with cylinder head screw	Blue, painted (RAL 5022) ■ M24 x 1.5 ■ ½ NPT
	BSZ-K	Plastic	■ M20 x 1.5 ■ ½ NPT	IP65	Spherical hinged cover with cylinder head screw	Black M24 x 1.5
	BSZ-H	Aluminium	■ M20 x 1.5 ■ ½ NPT	IP65	Raised hinged cover with cylinder head screw	Blue, painted (RAL 5022) ■ M24 x 1.5 ■ ½ NPT
	BSZ-H (2 x cable outlet)	Aluminium	■ 2 x M20 x 1.5 ■ 2 x ½ NPT	IP65	Raised hinged cover with cylinder head screw	Blue, painted (RAL 5022) M24 x 1.5
	BSZ-H / DIH10 3)	Aluminium	■ M20 x 1.5 ■ ½ NPT	IP65	Raised hinged cover with cylinder head screw	Blue, painted (RAL 5022) ■ M24 x 1.5 ■ ½ NPT
	BSZ-H / TND 4)	Aluminium	■ M20 x 1.5 ■ ½ NPT	IP65	Raised hinged cover with cylinder head screw	Blue, painted (RAL 5022) ■ M24 x 1.5 ■ ½ NPT
	BSZ-HK	Plastic	■ M20 x 1.5 ■ ½ NPT	IP65	Raised hinged cover with cylinder head screw	Black M24 x 1.5
	BS	Aluminium	■ M20 x 1.5 ■ ½ NPT	IP65	Flat cover with 2 screws	Blue, painted (RAL 5022) ■ M24 x 1.5 ■ ½ NPT
	BSS	Aluminium	■ M20 x 1.5 ■ ½ NPT	IP65	Spherical hinged cover with clamping lever	Blue, painted (RAL 5022) ■ M24 x 1.5 ■ ½ NPT
	BSS-H	Aluminium	■ M20 x 1.5 ■ ½ NPT	IP65	Raised hinged cover with clamping lever	Blue, painted (RAL 5022) ■ M24 x 1.5 ■ ½ NPT
	BVS	Stainless steel	M20 x 1.5	IP65	Precision-cast screw-on lid	Natural finish, electro-polished M24 x 1.5

1) IP ingress protection of the connection head. The IP ingress protection of the complete TR10-B instrument does not necessarily have to correspond to the connection head.

2) Suitable sealing / cable gland required.

3) LED display DIH10 in combination with transmitter with 4 ... 20 mA output (loop)

4) LC display TND in combination with T38

→ Further thread sizes on request

Model	Explosion protection					
	Without	Ex i (gas) Zone 0, 1, 2	Ex i (dust) Zone 20, 21, 22	Ex e (gas) Zone 1, 2	Ex t (dust) Zone 21, 22	Ex nA (gas) Zone 2
BSZ	x	x	x	x ¹⁾	x ¹⁾	x ²⁾
BSZ-K	x	x	-	-	-	-
BSZ-H	x	x	x	x ¹⁾	x ¹⁾	x ²⁾
BSZ-H (2 x cable outlet)	x	x	x	x ¹⁾	x ¹⁾	x ²⁾
BSZ-H / DIH10³⁾	x	x	-	-	-	-
BSZ-H / TND⁴⁾	x	x	-	-	-	-
BSZ-HK	x	x	-	-	-	-
BS	x	x	x	-	-	-
BSS	x	x	-	-	-	-
BSS-H	x	x	-	-	-	-
BVS	x	x	-	-	-	-







1) Only ATEX

2) Only ATEX and EACEx

3) LED display DIH10 in combination with transmitter with 4 ... 20 mA output (loop)

4) LC display TND in combination with T38

■ International connection heads

Model	Material	Cable inlet thread size	Ingress protection (max.) ^{1) 2)} IEC/EN 60529	Cap	Surface	Connection to neck tube	
	KN4-A	Aluminium	■ ½ NPT ■ M20 x 1.5	IP65	Screw-on lid	Blue, painted (RAL 5022)	■ M24 x 1.5 ■ ½ NPT
	KN4-P ³⁾	Polypropylene	½ NPT	IP65	Screw-on lid	White	½ NPT
	1/4000	Aluminium	■ ½ NPT ■ ¾ NPT ■ M20 x 1.5	IP66	Screw-on lid	Blue, painted (RAL 5022)	½ NPT
	1/4000	Stainless steel	■ ½ NPT ■ ¾ NPT ■ M20 x 1.5	IP66	Screw-on lid	Natural finish	½ NPT
	7/8000	Aluminium	■ ½ NPT ■ ¾ NPT ■ M20 x 1.5	IP66	Screw-on lid	Blue, painted (RAL 5022)	½ NPT
	7/8000	Stainless steel	■ ½ NPT ■ ¾ NPT ■ M20 x 1.5	IP66	Screw-on lid	Natural finish	½ NPT
	7/8000 / DIH50 ⁴⁾	Aluminium	■ ½ NPT ■ ¾ NPT ■ M20 x 1.5	IP66	Screw-on lid	Blue, painted (RAL 5022)	½ NPT
	7/8000 / DIH50 ⁴⁾	Stainless steel	■ ½ NPT ■ ¾ NPT ■ M20 x 1.5	IP66	Screw-on lid	Natural finish	½ NPT
	PIH-L	Aluminium	■ ½ NPT / closed ■ M20 x 1.5 / closed ■ 2 x ½ NPT ■ 2 x M20 x 1.5	IP66	Screw-on lid, flat	Blue upper body, painted (RAL 5022) Grey lower body, painted (RAL 7032)	■ ½ NPT ■ M20 x 1.5
	PIH-H	Aluminium	■ ½ NPT ■ M20 x 1.5 ■ 2 x ½ NPT ■ 2 x M20 x 1.5	IP66	Screw-on lid, high	Blue upper body, painted (RAL 5022) Grey lower body, painted (RAL 7032)	■ ½ NPT ■ M20 x 1.5
	PIH-W / TND ⁵⁾	Aluminium	■ ½ NPT ■ M20 x 1.5 ■ 2 x ½ NPT ■ 2 x M20 x 1.5	IP66	Screw-on lid, high	Blue upper body, painted (RAL 5022) Grey lower body, painted (RAL 7032)	■ ½ NPT ■ M20 x 1.5

- 1) IP ingress protection of the connection head. The IP ingress protection of the complete TR10-B instrument does not necessarily have to correspond to the connection head.
2) Suitable sealing / cable gland required.
3) On request.
4) LC display DIH50 in combination with transmitter with 4...20 mA output (loop).
5) LC display TND in combination with T38

Model	Explosion protection					
	Without	Ex i (gas) Zone 0, 1, 2	Ex i (dust) Zone 20, 21, 22	Ex e (gas) Zone 1, 2	Ex t (dust) Zone 21, 22	Ex nA (gas) Zone 2
KN4-A	x	x	-	-	-	-
KN4-P ¹⁾	x	-	-	-	-	-
1/4000	x	x	x	x	x	x
7/8000	x	x	x	x	x	x
7/8000 / DIH50 ²⁾	x	x	x	-	-	-
PIH-L / PIH-H	x	x	x	x	x	x
PIH-W / TND ³⁾	x	x	x	x	x	x

1) On request

2) LC display DIH50 in combination with transmitter with 4...20 mA output (loop)

3) LC display TND in combination with T38

Connection head with digital indicator



Connection head BSZ-H with model TND LC display
→ see data sheet TE 38.01



Connection head PIH-W with model TND LC display
→ see data sheet TE 38.01 and AC 80.30



Connection head BSZ-H with model DIH10 LED display
→ see data sheet AC 80.11











Connection head 7/8000 W with model DIH50 LC display
→ see data sheet AC 80.10

For operation of the TND digital indicator, a model T38 transmitter is always required.

To operate the DIH10 and DIH50 digital indicators, a transmitter with a 4 ... 20 mA output is always required.

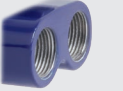
Cable inlet

Cable inlet	Colour	Ingress protection (max.) IEC/EN 60529 ¹⁾	Cable inlet thread size	Min./Max. ambient temperature	
	Natural finish	IP65	M20 x 1.5	-40 ... +80 °C [-40 ... +176 °F]	
	<ul style="list-style-type: none"> ■ Black ■ Grey 	IP66	<ul style="list-style-type: none"> ■ M20 x 1.5 ■ ½ NPT 	-40 ... +80 °C [-40 ... +176 °F]	
	<ul style="list-style-type: none"> ■ Light blue ■ Black 	IP66	<ul style="list-style-type: none"> ■ M20 x 1.5 ■ ½ NPT 	<ul style="list-style-type: none"> ■ -20 ... +80 °C [-4 ... +176 °F] ■ -40 ... +70 °C [-40 ... +158 °F] 	
	Nickel-plated brass cable gland (cable Ø 6 ... 12 mm)	Natural finish	IP66	<ul style="list-style-type: none"> ■ M20 x 1.5 ■ ½ NPT 	-60 ³⁾ / -40 ... +80 °C [-76 / -40 ... +176 °F]
	Nickel-plated brass cable gland (cable Ø 6 ... 12 mm), Ex e	Natural finish	IP66	<ul style="list-style-type: none"> ■ M20 x 1.5 ■ ½ NPT 	-60 ³⁾ / -40 ... +80 °C [-76 / -40 ... +176 °F]
	Stainless steel cable gland (cable Ø 7 ... 12 mm)	Natural finish	IP66	<ul style="list-style-type: none"> ■ M20 x 1.5 ■ ½ NPT 	-60 ³⁾ / -40 ... +80 °C [-76 / -40 ... +176 °F]
	Stainless steel cable gland (cable Ø 7 ... 12 mm), Ex e	Natural finish	IP66	<ul style="list-style-type: none"> ■ M20 x 1.5 ■ ½ NPT 	-60 ³⁾ / -40 ... +80 °C [-76 / -40 ... +176 °F]
	-	IP00	<ul style="list-style-type: none"> ■ M20 x 1.5 ■ ½ NPT 	-	
	-	IP00	<ul style="list-style-type: none"> ■ 2 x M20 x 1.5 ■ 2 x ½ NPT 	-	
	-	IP65	M20 x 1.5	-40 ... +80 °C [-40 ... +176 °F]	
	Transparent	-	<ul style="list-style-type: none"> ■ M20 x 1.5 ■ ½ NPT 	-40 ... +80 °C [-40 ... +176 °F]	

1) IP ingress protection of the cable gland. The IP protection of the complete TR10-B instrument does not necessarily have to correspond to the cable gland.

2) Not available for BVS connection head

3) Special version on request (explosion-protected versions only available with specific approvals)

4) Only for BSZ-H connection head

Cable inlet	Explosion protection					
	With-out	Ex i (gas) Zone 0, 1, 2	Ex i (dust) Zone 20, 21, 22	Ex e (gas) Zone 1, 2	Ex t (dust) Zone 21, 22	Ex nA (gas) Zone 2
Standard cable inlet ^{1) 3)}	x	x	-	-	-	-
Plastic cable gland ¹⁾	x	x	-	-	-	-
Plastic cable gland (light blue), Ex e ¹⁾	x	x	x	-	-	-
Plastic cable gland (black), Ex e ¹⁾	x	x	x	x	x	x
Brass cable gland, nickel-plated	x	x	x	-	-	-
Brass cable gland, nickel-plated, Ex e	x	x	x	x	x	x
Stainless steel cable gland	x	x	x	-	-	-
Stainless steel cable gland, Ex e	x	x	x	x	x	x
Plain threaded	x	x	x ⁵⁾	x ⁵⁾	x ⁵⁾	x ⁵⁾
2 x plain threaded ²⁾	x	x	x ⁵⁾	x ⁵⁾	x ⁵⁾	x ⁵⁾
Junction box M12 x 1 (4-pin) ³⁾	x	x ⁴⁾	x ⁴⁾	-	-	-
Sealing plugs for shipping	Not applicable, transport protection ⁵⁾					



- 1) Not available for BVS connection head
2) Only for BSZ-H connection head
3) Not available for ½ NPT thread size cable entry
4) With appropriate mating connector connected
5) Suitable cable gland required for operation

Measuring insert

Measuring insert		
Version	Vibration-resistant mineral-insulated metal-sheathed cable (MIMS cable)	
Optimal heat transfer	Requirement <ul style="list-style-type: none"> ■ Correct measuring insert length ■ Correct measuring insert diameter 	
	Bore diameter of the thermowell	Max. 1 mm [0.039 in] larger than the measuring insert diameter
	Gap width	With gap widths > 0.5 mm [> 0.020 in] between thermowell and measuring insert: → Negative impact on heat transfer → Unfavourable response behaviour of the thermometer
Insertion length	When fitting the measuring insert into a thermowell, it is very important to determine the correct insertion length (= thermowell length for tip thicknesses of ≤ 5.5 mm [≤ 0.217 in]). In order to ensure that the measuring insert is firmly pressed down onto the bottom of the thermowell, the insert must be spring-loaded (spring travel: max. 10 mm [0.394 in]).	
Spring travel	Max. 10 mm [0.394 in]	

Measuring insert diameter Ø d in mm [in]	Index per DIN 43735	Tolerance in mm	Sheath material
3 [0.118]	Standard	3 ^{+0.05} _{-0.05}	■ 1.4571 ■ 316L
6 [0.236]	Standard	6 ⁰ _{-0.1}	■ 1.4571
8 [0.315] (6 mm [0.236] with sleeve)	Standard	8 ⁰ _{-0.1}	■ 1.4571 ■ 316L
8 [0.315]	Standard	8 ⁰ _{-0.1}	■ 1.4571 ■ 316L

Transmitter

Transmitter models	Model T15	Model T32	Model T38
Transmitter data sheet	TE 15.01	TE 32.04	TE 38.01
Figure			
Output signal			
4 ... 20 mA	x	x	x
HART® protocol	-	x	x
WIKA True Drift Detection	-	-	x
			→ See data sheet SP 05.26
Connection method	<ul style="list-style-type: none"> ■ 1 x 2-wire ■ 1 x 3-wire ■ 1 x 4-wire 	<ul style="list-style-type: none"> ■ 1 x 2-wire ■ 1 x 3-wire ■ 1 x 4-wire ■ 2 x 2-wire 	<ul style="list-style-type: none"> ■ 1 x 2-wire ■ 1 x 3-wire ■ 1 x 4-wire ■ 2 x 2-wire ■ 2 x 3-wire
Measuring current	< 0.2 mA	< 0.3 mA	< 0.33 mA
Explosion protection	Ex version possible		
Mounting types			
Mounting onto the measuring insert	With mounting on the measuring insert, the transmitter replaces the terminal block and is fixed directly to the terminal plate of the measuring insert.		
Mounted within the cover of the connection head	Mounting the transmitter in the cover of the connection head is preferable to mounting it on the measuring insert. With this mounting type, for one, a better thermal insulation is ensured, and in addition, exchange and mounting for servicing is simplified.		

Mounting types

Mounting onto the measuring insert



Measuring insert with mounted transmitter (here: model T32)

Measuring insert prepared for transmitter mounting

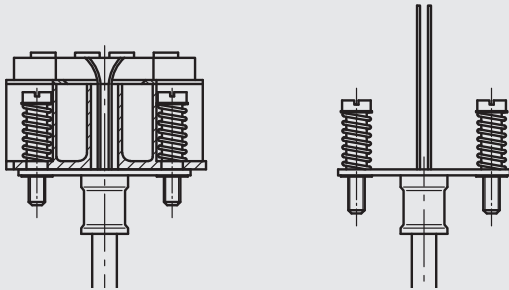

Mounted within the cover of the connection head

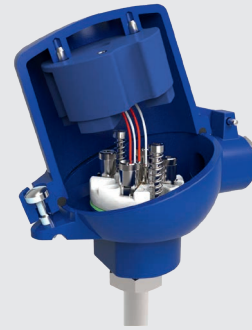

When using dual sensors in combination with a single transmitter, sensor 1 is connected to the transmitter. The connection leads of sensor 2 (insulated against short-circuits) protrude loosely into the connection head.

Exceptions

- T32: The combination of a 2 x 2-wire in conjunction with a T32 transmitter in the “redundancy” configuration.
- T38: The combination of a 2 x 2-wire or 2 x 3 wire in combination with a T38 transmitter in the “redundancy” configuration.

WIKA- True Drift Detection



Special dual sensor functionality

- Special probe (RTD/TC combination, realised in the common probe tip of a measuring insert with 6 mm diameter, in combination with T38 transmitter)
- Permanent monitoring of the resistance sensor by the reference thermocouple
- A wrong reading can be detected immediately and before the next recalibration. Uncertainties between the calibration intervals are thus eliminated
- Error signalling in accordance with NAMUR NE043, can be configured according to customer specifications
- Individual monitoring of the single measuring locations
- Process optimisation

Possible mounting positions for transmitters	Model T15	Model T32	Model T38
BSZ	○	○	○
BSZ-K	○	○	○
BSZ-H	●	●	●
BSZ-H (2x cable outlet)	●	●	●
BSZ-H / DIH10	○	○	○
BSZ-H / TND	○	○	○
BSZ-HK	●	●	●
BS	○	-	-
BSS	○	○	○
BSS-H	●	●	●
BVS	○	○	○
KN4-A	○	○	○
KN4-P	○	○	○
1/4000	○	○	○
7/8000	○	○	○
7/8000 / DIH50	○	○	○
PIH-L / PIH-H	○	○	○
PIH-W	○	○	○

Legend:

- Mounted instead of terminal block
- Mounted within the cover of the connection head
- Mounting not possible

The mounting of a transmitter on the measuring insert is possible with all the connection heads listed here. The fitting of a transmitter in the (screw) cap of a connection head is not possible. Mounting of 2 transmitters on request.

For a correct determination of the overall measuring deviation, the sensor and transmitter measuring deviations must be added.

Functional safety with model T32 and T38 temperature transmitter



In safety-critical applications, the entire measuring chain must be taken into consideration in terms of the safety parameters. The SIL classification allows the assessment of the risk reduction achieved by the safety installations.

Selected TR10-B resistance thermometers, in combination with a suitable temperature transmitter (e.g. model T32 or T38, TÜV certified SIL version for protection systems developed in accordance with IEC 61508), are suitable as sensors for safety functions to SIL 2.

For SIL 3 applications, WIKA recommends the use of two individual TR10-B with one SIL-certified T32 or T38 transmitter connected to each.

→ For detailed specifications, see technical information IN 00.19 at www.wika.com.

Neck tube

Thread sizes				
Neck tube design	Diameter	Thread to the thermowell	Connection to head	Materials ¹⁾
Neck tube per DIN 43772	■ 12 x 1.5 mm [0.472 x 0.059 in]	<ul style="list-style-type: none"> ■ G ½ B ■ G ¾ B ■ G ¼ B ■ M20 x 1.5 ■ M18 x 1.5 ■ M14 x 1.5 ■ ½ NPT ■ ¾ NPT ■ G ½ B compression fitting (metal ferrule) ■ G ¾ B compression fitting (metal ferrule) ■ M18 x 1.5 compression fitting (metal ferrule) ■ M20 x 1.5 compression fitting (metal ferrule) ■ G ½ B union nut ■ G ¾ B union nut ■ M20 x 1.5 union nut ■ G ½ B male nut ■ G ¾ B male nut ■ M20 x 1.5 male nut ■ Without threaded connection, plain 	M24 x 1.5 (swivel connection)	1.4571
	■ 12 x 2.5 mm [0.472 x 0.098 in]			
Neck tube per DIN 43772	14 x 2.5 mm [0.551 x 0.098 in]	<ul style="list-style-type: none"> ■ G ½ B ■ G ¾ B ■ G ¼ B ■ M20 x 1.5 ■ M18 x 1.5 ■ M14 x 1.5 ■ ½ NPT ■ ¾ NPT ■ G ½ B union nut ■ G ¾ B union nut ■ M20 x 1.5 union nut ■ G ½ B male nut ■ G ¾ B male nut ■ M20 x 1.5 male nut 		
Neck tube with counter nut to head	14 x 2.5 mm [0.551 x 0.098 in]	<ul style="list-style-type: none"> ■ ½ NPT ■ ¾ NPT ■ G ½ B ■ G ¾ B ■ G ¼ B ■ M14 x 1.5 ■ M18 x 1.5 ■ M20 x 1.5 	M20 x 1.5 (with counter nut)	1.4571
Double threaded hex bushing (with hexagonal spanner flats)	-	<ul style="list-style-type: none"> ■ G ½ B ■ G ¾ B ■ G ¼ B ■ ½ NPT ■ ¾ NPT ■ M14 x 1.5 ■ M18 x 1.5 ■ M20 x 1.5 	M24 x 1.5, ½ NPT	1.4571
“Nipple-union-nipple” neck tube ²⁾	~ 22 mm [~ 0.9 in]	½ NPT	½ NPT	316
	~ 27 mm [~ 1.1 in]	¾ NPT	¾ NPT	316
Double threaded hex bushing (tube section)	~ 22 mm [~ 0.9 in]	½ NPT	½ NPT	316
	~ 27 mm [~ 1.1 in]	¾ NPT	¾ NPT	316

1) Other materials on request

2) Union material: stainless steel

Neck length		
Neck tube design	Neck length	Min. / Max. neck length
Neck tube per DIN 43772	150 mm [~ 6 in]	<ul style="list-style-type: none"> ■ 30 mm [~ 1.2 in] ■ 500 mm [~ 20 in]
Neck tube per DIN 43772, plain	150 mm [~ 6 in]	<ul style="list-style-type: none"> ■ 75 mm [~ 3 in] ■ 900 mm [~ 35 in]
Neck tube with counter nut to head	150 mm [~ 6 in]	<ul style="list-style-type: none"> ■ 75 mm [~ 3 in] ■ 250 mm [~ 10 in]
Double threaded hex bushing (with hexagonal spanner flats)		
M24 x 1.5 to connection head, parallel thread to thermowell / protection tube	13 mm [0.512 in]	-
1/2 NPT to connection head, parallel thread to thermowell	~ 25 mm [1 in]	-
M24 x 1.5 to connection head, tapered thread to thermowell	~ 25 mm [1 in]	-
1/2 NPT to connection head, tapered thread to thermowell	~ 25 mm [1 in]	-
“Nipple-union-nipple” neck tube	~ 150 mm [6 in]	<ul style="list-style-type: none"> ■ ~ 75 mm [3 in] ■ ~ 250 mm [10 in]
Double threaded hex bushing (tube section)	~ 50 mm [2 in]	<ul style="list-style-type: none"> ■ ~ 50 mm [2 in] ■ ~ 250 mm [10 in]

The neck tube is screwed into the connection head. The neck length depends on the intended use. Usually an isolation is bridged by the neck tube. Also, in many cases, the neck tube serves as a cooling element between the connection head and the medium, in order to protect a possible built-in transmitter from high medium temperatures.

→ Other versions on request.

Operating conditions

Operating conditions	
Ambient and storage temperature	<ul style="list-style-type: none"> ■ -40 ... +80 °C [-40 ... +176 °F] ■ -60 ¹⁾ ... +80 °C [-76 ... +176 °F]
Vibration resistance	The information on vibration resistance refers to the tip of the measuring insert.

1) Special version on request (explosion-protected versions only available with specific approvals)

Examples of vibration resistance		
	Measuring insert Ø 6 mm [0.236 in]	Measuring insert Ø 3 mm [0.118 in]
Thermometer version		
Sensor	<ul style="list-style-type: none"> ■ 1 x Pt100 (thin film) ■ 2 x Pt100 (thin film) 	<ul style="list-style-type: none"> ■ 1 x Pt100 (thin film) ■ 2 x Pt100 (thin film)
Connection method	<ul style="list-style-type: none"> ■ 3-wire ■ 4-wire 	<ul style="list-style-type: none"> ■ 3-wire ■ 4-wire (only 1 x Pt100)
Diameter	Ø 6 mm [0.236 in]	Ø 3 mm [0.118 in]
Insertion length (A) + neck length (N)	100 ... 1,100 mm [~ 4 ... 43 in]	100 ... 1,100 mm [~ 4 ... 43 in]
Material	<ul style="list-style-type: none"> ■ Stainless steel 1.4571 ■ Stainless steel 316L 	<ul style="list-style-type: none"> ■ Stainless steel 1.4571 ■ Stainless steel 316L
Vibration resistance		
Standard probe tip, (max. 3 g amplitude / 6 g peak-to-peak)	x	x
Vibration-resistant probe tip (max. 10 g amplitude / 20 g peak-to-peak)	x	x
Highly vibration-resistant probe tip (max. 25 g amplitude / 50 g peak-to-peak)	x	x
Extremely vibration-resistant probe tip (max. 50 g amplitude / 100 g peak-to-peak)	x	-

The thermometer designs listed above describe instruments in standard designs.

Vibration resistance test in per IEC 60068-2-6. Vibration resistance of thermometers in other configurations as well as vibration resistance higher than 50 g amplitude / 100 g tip - tip on request.

IP ingress protection per IEC/EN 60529

First index number	Degree of protection / Short description	Test parameters
Degrees of protection against solid foreign bodies (defined by the 1st index number)		
5	Dust-protected	Per IEC/EN 60529
6	Dust-tight	Per IEC/EN 60529
Degrees of protection against water (defined by the 2nd index number)		
4	Protected against splash water	Per IEC/EN 60529
5	Protected against water jets	Per IEC/EN 60529
6	Protected against strong water jets	Per IEC/EN 60529

Standard ingress protection of model TR10-B is IP65.

The specified degrees of protection apply under the following conditions:

- Use of a suitable thermowell (without suitable thermowell: IP40)
- Use of a suitable cable gland
- Use of a cable cross-section appropriate for the gland or select the appropriate cable gland for the available cable
- Adhere to the tightening torques for all threaded connections

Examples of response time		
	Measuring insert Ø 6 mm [0.236 in]	Measuring insert Ø 3 mm [0.118 in]
Thermometer version		
Sensor	<ul style="list-style-type: none"> ■ 1 x Pt100 (thin film) ■ 2 x Pt100 (thin film) 	<ul style="list-style-type: none"> ■ 1 x Pt100 (thin film) ■ 2 x Pt100 (thin film)
Connection method	<ul style="list-style-type: none"> ■ 3-wire ■ 4-wire 	<ul style="list-style-type: none"> ■ 3-wire ■ 4-wire (only 1 x Pt100)
Diameter	Ø 6 mm [0.236 in]	Ø 3 mm [0.118 in]
Insertion length (A) + neck length (N)	100 ... 1,100 mm [~ 4...43 in]	100 ... 1,100 mm [~ 4...43 in]
Material	<ul style="list-style-type: none"> ■ Stainless steel 1.4571 ■ Stainless steel 316L 	<ul style="list-style-type: none"> ■ Stainless steel 1.4571 ■ Stainless steel 316L
Response time in seconds (+/- 10 %)		
$t_{0,5}$	3.8	2.8
$t_{0,63}$	4.8	3.5
$t_{0,9}$	8.6	6.6

All response times listed apply for versions without mounted thermowell.

Fundamentals of measurements:

VDI/VDE directive 3522 part 1: Dynamic behaviour of contact thermometers / Principles and characteristic values

VDI/VDE directive 3522 part 2 Dynamic behaviour of contact thermometers / Experimental determination of time percentage values







IEC 60751 Definition of thermal response time / Specification of measurement parameters

IEC 60751 Thermal response time

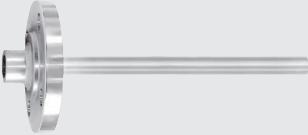
Medium to be measured: water

Response times of thermometers in other dimensions, configurations or materials on request.

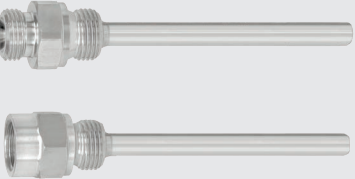
Thermowell

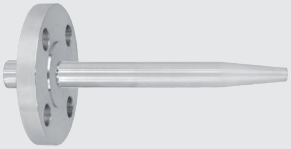
Thermowell selection		
Illustration	Model	Data sheet
	TW10	<ul style="list-style-type: none"> ■ TW 95.10 ■ TW 95.11 ■ TW 95.12
	TW15	TW 95.15
	TW20	TW 95.20
	TW25	TW 95.25
	TW30	TW 95.30
	TW45	TW 95.45
	TW50	TW 95.50
	TW55	TW 95.55

→ Further special thermowells on request.



Approvals







Approvals included in the scope of delivery

Logo	Description	Country
	EU declaration of conformity	European Union
	EMC directive ¹⁾ EN 61326 emission (group 1, class B) and immunity (industrial application)	
	RoHS directive	

1) Only for built-in transmitter

Optional approvals

Logo	Description	Country
	EU declaration of conformity ATEX directive Hazardous areas - Ex i Zone 0 gas II 1G Ex ia IIC T6 ... T1 Ga Zone 1 gas II 2G Ex ia IIC T6 ... T1 Gb Zone 1 mounting to zone 0 gas II 1/2G Ex ia IIC T6 ... T1 Ga/Gb Zone 20 dust II 1D Ex ia IIIC T ₂₀₀ X °C Da Zone 21 dust II 2D Ex ia IIIC TX °C Db Zone 21 mounting to zone 20 dust II 1/2D Ex ia IIIC TX °C Da/Db - Ex e ¹⁾ Zone 1 gas II 2G Ex eb IIC T1 ... T6 Gb ³⁾ Zone 2 gas II 3G Ex ec IIC T1 ... T6 Gc X Zone 21 dust II 2D Ex tb IIIC TX °C Db ³⁾ Zone 22 dust II 3D Ex tc IIIC TX °C Dc X - Ex t ¹⁾ Zone 21 dust II 2D Ex tb IIIC TX °C Db ³⁾ Zone 22 dust II 3D Ex tc IIIC TX °C Dc X	European Union
	IECEx Hazardous areas - Ex i Zone 0 gas Ex ia IIC T6 ... T1 Ga Zone 1 gas Ex ia IIC T6 ... T1 Gb Zone 1 mounting to zone 0 gas Ex ia IIC T6 ... T1 Ga/Gb Zone 20 dust Ex ia IIIC T ₂₀₀ X °C Da Zone 21 dust II 2D Ex ia IIIC TX °C Db Zone 21 mounting to zone 20 dust II 1/2D Ex ia IIIC TX °C Da/Db - Ex e ²⁾ Zone 1 gas Ex eb IIC T1 ... T6 Gb ³⁾ Zone 2 gas Ex ec IIC T1 ... T6 Gc Zone 21 dust Ex tb IIIC TX °C Db ³⁾ Zone 22 dust Ex tc IIIC TX °C Dc - Ex t ²⁾ Zone 21 dust Ex tb IIIC TX °C Db ³⁾ Zone 22 dust Ex tc IIIC TX °C Dc	International
-	ECASEx Hazardous areas - Ex e ²⁾ Zone 1 gas Ex eb IIC T1 ... T6 Gb ³⁾ Zone 2 gas Ex ec IIC T1 ... T6 Gc Zone 21 dust Ex tb IIIC TX °C Db ³⁾ Zone 22 dust Ex tc IIIC TX °C Dc - Ex n ²⁾ Zone 2 gas Ex nA IIC T1 ... T6 Gc - Ex t ²⁾ Zone 21 dust Ex tb IIIC TX °C Db ³⁾ Zone 22 dust Ex tc IIIC TX °C Dc	United Arab Emirates
	Ex Ukraine Hazardous areas - Ex i Zone 0 gas II 1G Ex ia IIC T1 ... T6 Ga Zone 1 gas II 2G Ex ia IIC T1 ... T6 Gb Zone 1 mounting to zone 0 gas II 1/2G Ex ia IIC T1 ... T6 Ga/Gb Zone 20 dust II 1D Ex ia IIIC T65°C Da Zone 21 dust II 2D Ex ia IIIC T65°C Db Zone 21 mounting to zone 20 dust II 1/2D Ex ia IIIC T65°C Da/Db	Ukraine

Logo	Description	Country
	INMETRO Hazardous areas - Ex i Zone 0 gas Ex ia IIC T3 ... T6 Ga Zone 1 mounting to zone 0 gas Ex ia IIC T3 ... T6 Ga/Gb Zone 20 dust Ex ia IIIC T125 ... T65 °C Da Zone 21 mounting to zone 20 dust Ex ia IIIC T125 ... T65 °C Da/Db	Brazil
	CCC ³⁾ Hazardous areas - Ex i Zone 0 gas Ex ia IIC T1 ... T6 Ga Zone 1 gas Ex ia IIC T1 ... T6 Gb Zone 1 mounting to zone 0 gas Ex ia IIC T1 ... T6 Ga/Gb Zone 20 dust Ex ia IIIC T ₂₀₀ 65°C/T ₂₀₀ 95°C/T ₂₀₀ 125°C Da Zone 21 dust Ex ia IIIC T65°C/T95°C/T125°C Db Zone 21 mounting to zone 20 dust Ex ia IIIC T ₂₀₀ 65°C/T ₂₀₀ 95°C/T ₂₀₀ 125°C Da/Db - Ex e ²⁾ Zone 1 gas Ex eb IIC T1 ... T6 Gb Zone 2 gas Ex ec IIC T1 ... T6 Gc - Ex t ²⁾ Zone 22 mounting to zone 21 dust Ex tb IIIC T135 °C Db/Dc	China
	NEPSI ⁴⁾ Hazardous areas - Ex i Zone 0 gas Ex ia IIC T1 ~ T6 Ga Zone 1 gas Ex ia IIC T1 ~ T6 Gb Zone 1 mounting to zone 0 gas Ex ia IIC T1 ~ T6 Ga/Gb Zone 20 dust Ex iaD 20 T65/T95/T125°C Zone 21 dust Ex iaD 21 T65/T95/T125°C Zone 21 mounting to zone 20 dust Ex iaD 20/21 T65/T95/T125°C	China
	KCs Hazardous areas - Ex i Zone 0 gas Ex ia IIC T4 ... T6 Zone 1 gas Ex ib IIC T4 ... T6	South Korea
-	PESO Hazardous areas - Ex i Zone 0 gas Ex ia IIC T1 ... T6 Ga Zone 1 gas Ex ia IIC T1 ... T6 Gb Zone 1 mounting to zone 0 gas Ex ia IIC T1 ... T6 Ga/Gb	India
	EACEx Hazardous areas - Ex i Zone 0 gas 0 Ex ia IIC T6 ... T1 Ga X Zone 1 gas 1 Ex ia IIC T6 ... T1 Gb X Zone 20 dust Ex ia IIIC T80 ... T440 °C Da X Zone 21 dust Ex ia IIIC T80...T440 °C Db X - Ex e ²⁾ Zone 1 gas 1Ex eb IIC T6...T1 Gb X ³⁾ Zone 2 gas 2Ex ec IIC T6...T1 Gc X Zone 21 dust Ex tb IIIC T85 °C Db X ³⁾ Zone 22 dust Ex tc IIIC T85 °C Dc - Ex n ¹⁾ Zone 2 gas 2Ex nA IIC T6 ... T1 Gc X - Ex t ²⁾ Zone 21 dust Ex tb IIIC T85 °C Db X ³⁾ Zone 22 dust Ex tc IIIC T85 °C Dc X	Eurasian Economic Community
-	PAC Ukraine Metrology, measurement technology	Ukraine
	PAC Kazakhstan Metrology, measurement technology	Kazakhstan
-	MchS Permission for commissioning	Kazakhstan
	PAC Uzbekistan Metrology, measurement technology	Uzbekistan

Logo	Description	Country
	<p>DNV GL Type approval for the shipbuilding industry</p> <ul style="list-style-type: none"> - Maximum insertion length l_1: 435 mm - Connection head: Model BSZ - Neck tube: \varnothing 11 x 2 mm or \varnothing 12 x 2.5 mm, max. 150 mm long - Measuring insert: \varnothing 6 mm - Optional with TW10-P (see data sheets TW 95.10, TW 95.12) <p><i>Location classification:</i> Temperature D (ambient temperature: -25 ... +70 °C) Humidity B (relative humidity: up to 100 %) Vibration B (frequency: 3 ... 25 Hz; amplitude: 1.6 mm peak; frequency: 25 ... 100 Hz; amplitude: 4 g) EMC Not relevant Case Required protection in accordance with DNV rules shall be provided upon installation on board. For use on open deck a connection head with IP68 is required. ⁵⁾ (for "open deck")</p>	International

- 1) Only for connection head model BSZ, BSZ-H, 1/4000, 5/6000, 7/8000 or PI-housing, see "Connection head"
- 2) Only with connection head, model 1/4000, 5/6000, 7/8000 or PI-housing, see "Connection head"
- 3) Only without transmitter
- 4) Only with transmitter
- 5) Suitable cable gland required

Instruments marked with "ia" may also be used in areas only requiring instruments marked with "ib" or "ic". If an instrument with "ia" marking has been used in an area with requirements in accordance with "ib" or "ic", it can no longer be operated in areas with requirements in accordance with "ia" afterwards.

The permissible power, P_{max} , as well as the permissible ambient temperature, for the respective category can be seen on the Ex certificate or the operating instructions.

The transmitter have their own certificates for hazardous areas. The permissible ambient temperature ranges of the built-in transmitters can be taken from the corresponding transmitter operating instructions and approvals.

Manufacturer's information and certificates

Logo	Description
	<p>SIL 2 SIL 3 see page 12 Functional safety</p>
	<p>NAMUR NE 024 Hazardous areas (Ex i)</p>

Certificates

Certification type	Measurement accuracy	Material certificate ¹⁾
2.2 test report	x	x
3.1 inspection certificate	x	x
DAkkS calibration certificate	x	-

1) Thermowells have their own material certificates for selected components

For calibration, the measuring insert is removed from the thermometer. The minimum length (metal part of the probe) for carrying out a 3.1 measurement accuracy test or DAkkS is 100 mm [~ 4 in].

Calibration of shorter lengths as well as calibration of versions in 2-wire connection possible on request.

The different certifications can be combined with each other.

→ For approvals and certificates, see website

Dimensions in mm [in]

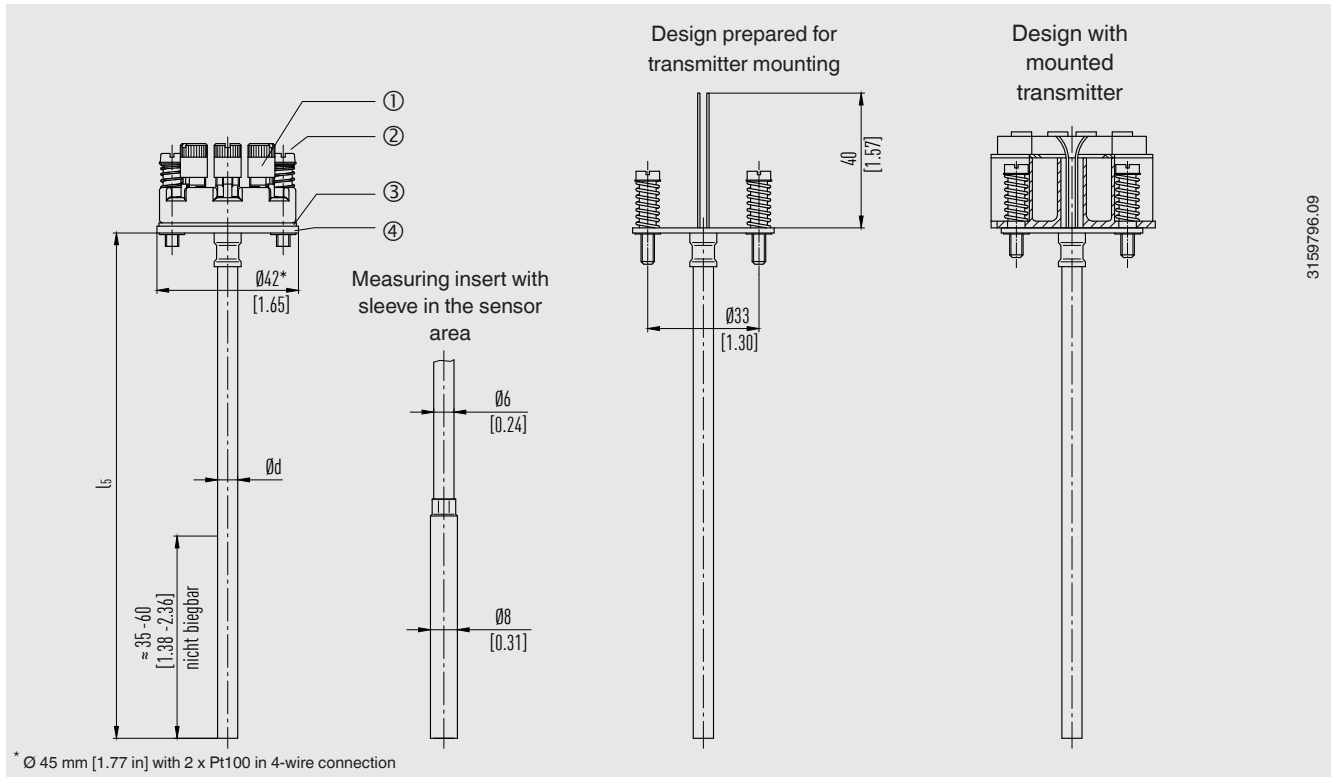

3159796.09

Legend

- ① Connection terminal
- ② Spring-loaded screw
- ③ Insulation washer
- ④ Terminal plate
- l_5 Measuring insert length
- $\varnothing d$ Measuring insert diameter

The following figures show examples of connection heads.

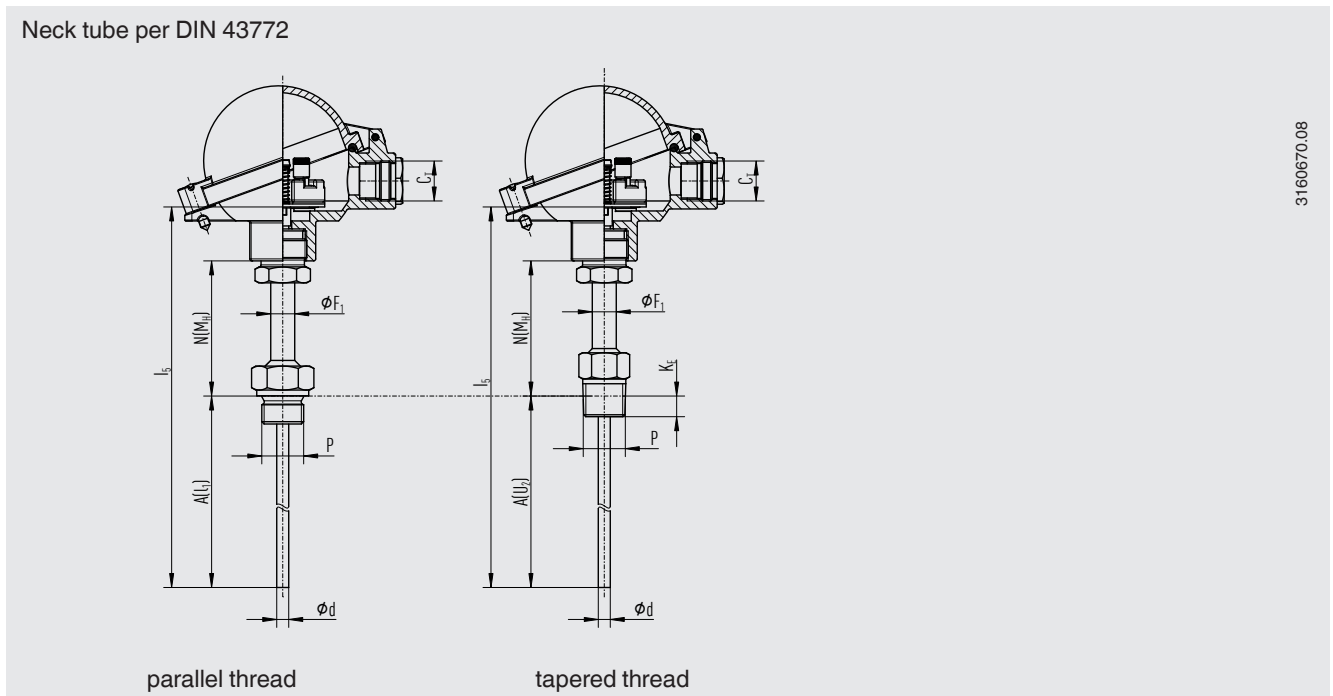

3160670.08

Neck tube per DIN 43772, plain, with/without compression fitting

3160688.07

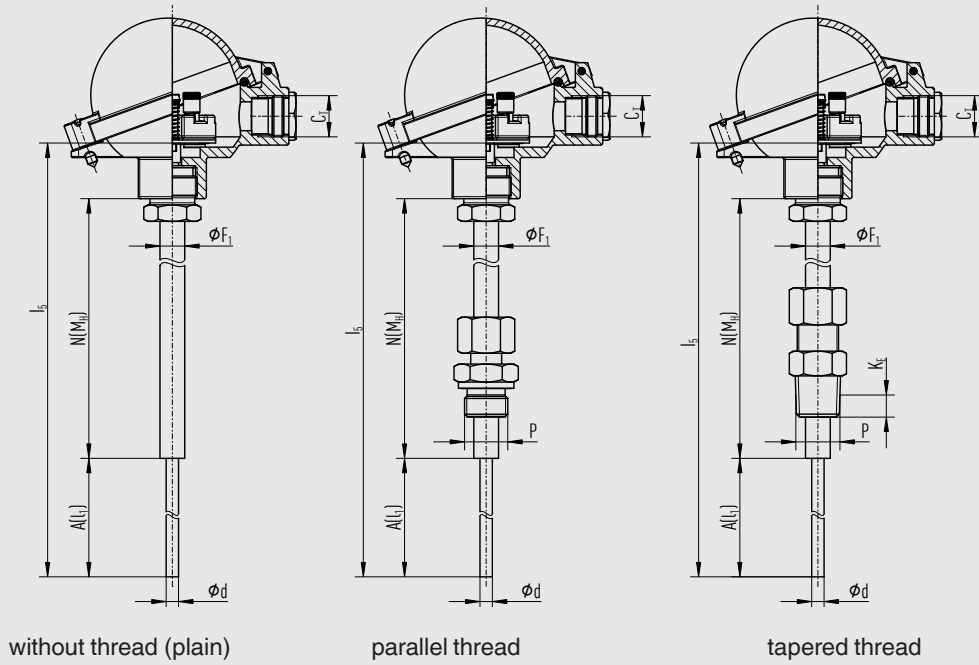

Legend:

- A (l₁) Insertion length (parallel threads)
- A (l₂) Insertion length (tapered threads)
- l_s Measuring insert length
- N (M_H) Neck length
- K_E ½ NPT: 8.13 mm [0.320 in]
¾ NPT: 8.61 mm [0.339 in]

- C_T Thread cable inlet
- Ø F₁ Neck tube diameter
- P Thread to the thermowell
- Ø d Measuring insert diameter

Neck tube, with counter nut to head

14111586.02

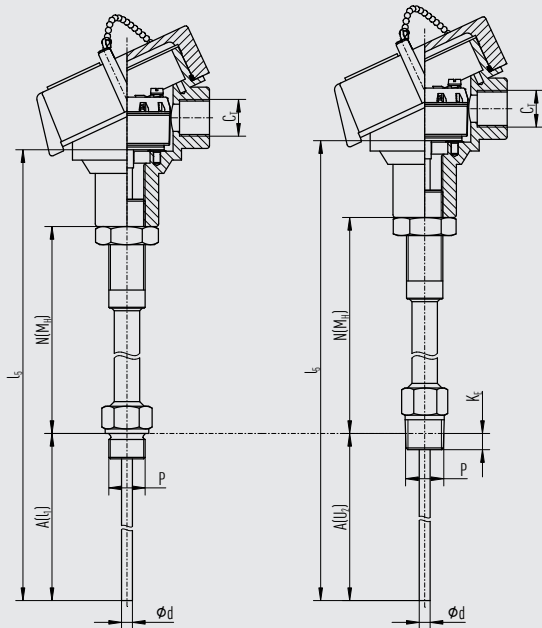

parallel thread

tapered thread

Double threaded hex bushing (with hexagonal spanner flats)

14111667.03

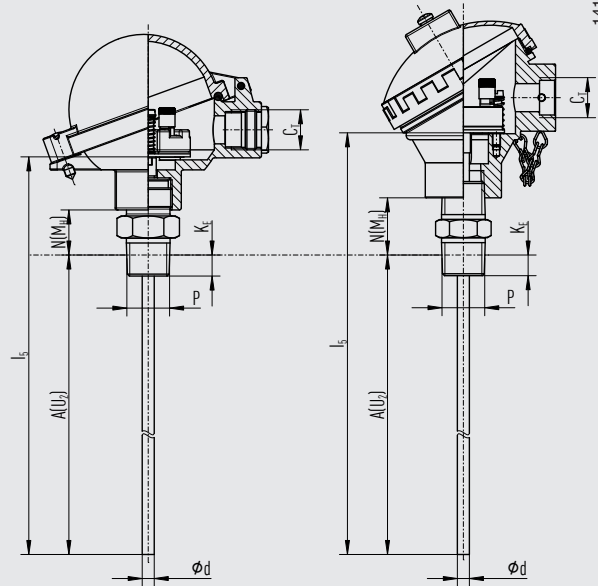

parallel thread

tapered thread

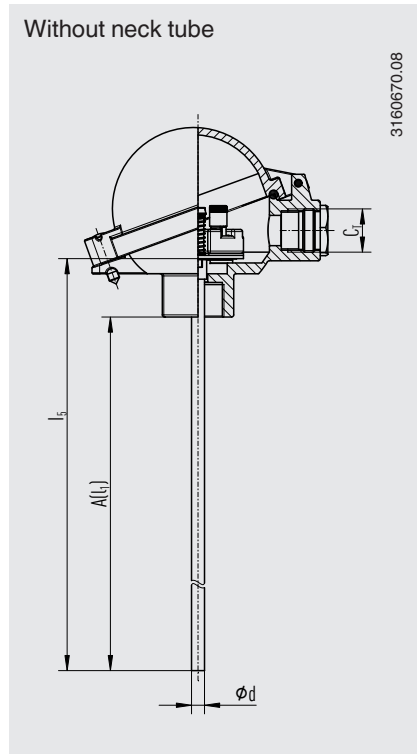
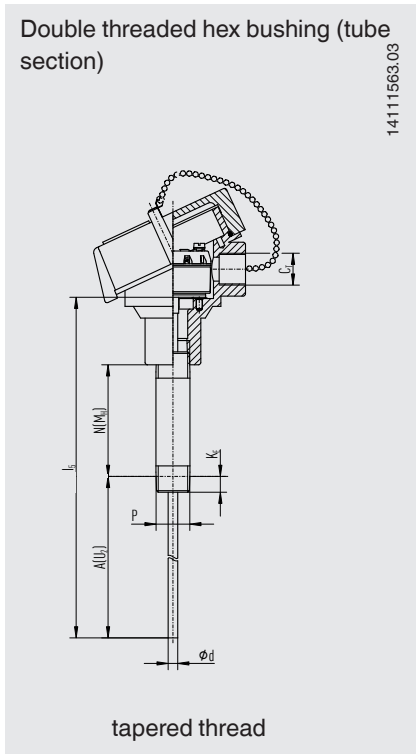
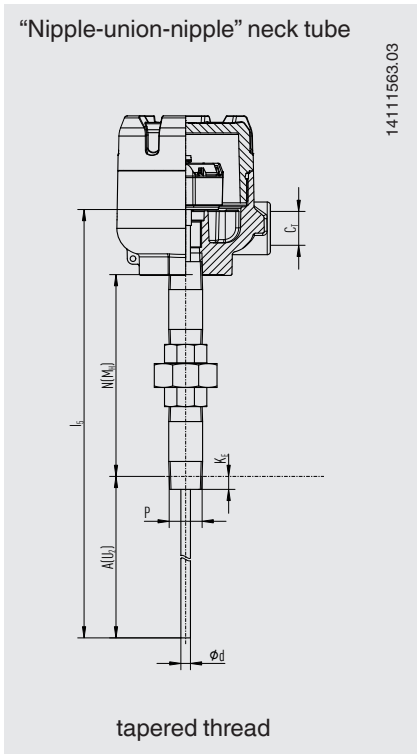

Legend:

- A (l₁) Insertion length (parallel threads)
- A (U₂) Insertion length (tapered threads)
- l₅ Measuring insert length
- N (M_H) Neck length
- K_E ½ NPT: 8.13 mm [0.320 in]
¾ NPT: 8.61 mm [0.339 in]

- C_T Thread cable inlet
- Ø F₁ Neck tube diameter
- P Thread to the thermowell
- Ø d Measuring insert diameter

Ordering information

Model / Explosion protection / Further approvals, certificates / Sensor / Accuracy class, range of use of the sensor / Connection housing / Cable inlet / Transmitter / Connection to neck tube / Neck tube / Thread size / Neck length N (M_H) / Insertion length A (l₁), A (U₂) / Measuring insert diameter Ø d / Measuring insert sheath material / Certificates / Options

© 04/2003 WIKA Alexander Wiegand SE & Co. KG, all rights reserved.
The specifications given in this document represent the state of engineering at the time of publishing.
We reserve the right to make modifications to the specifications and materials.

